

# Original Operating Instructions

**For ErgoPack**

**700X-AGM/713X-AGM/726X-AGM/745X-AGM**

# Declaration of conformity

## **EU declaration of conformity (for the purposes of the EU machine directive 2006/42/EG)**

We, ErgoPack Deutschland GmbH  
Hanns-Martin-Schleyer Str. 21  
89415 Lauingen

hereby declare, that the Ergonomic Pallet Strapping Systems type "ErgoPack 700X-AGM, 713X-AGM, 726X-AGM, 745X-AGM", to which this declaration refers, complies with the respective relevant and basic health and safety requirements of the EU directives because of their concept, type of construction and the model we have brought on to the market. This declaration loses its validity if a change is made to the system without our permission.

Respective  
EU directives: EU Machine directive (2006/42/EG)  
EU Guideline on electromagnetic compatibility  
(2014/30/EU)

Applied standards EN 12100: 2010  
EN 415-1: 2014  
EN 415-8: 2008  
EN 61000-4-3: 2006  
EN 55011: 2016

Since strapping system: 0421HPXXX/11505  
Since year of manufacture: 2021

Lauingen, 27th of April, 2021



Karlheinz Arker  
Technical Director

Authorised representative for publishing technical documentation:  
ErgoPack Deutschland GmbH  
Hanns-Martin-Schleyer-Str. 21  
D-89415 Lauingen

# Table of contents

<b>1. Validity of the operating instructions</b>	<b>5</b>
<b>2. General</b>	<b>6</b>
2.1 Moving the strapping system	6
2.2 Parking the strapping system	6
2.3 Work area space requirement	7
2.4 Environmental conditions	7
2.5 Energy supply charger/battery	8
2.6 Notes on environmental protection	9
2.7 Meaning of warning symbols, presentation conventions	10
2.7.1 Explanation of symbols	10
2.7.2 Explanation of the safety representation	11
<b>3. Recommendations for protective measures</b>	<b>12</b>
3.1 Safety regulations for battery and charger	13
<b>4. Description</b>	<b>14</b>
4.1 Design	14
4.2 Control panel strapping system	15
4.3 Touch display strapping system	15
4.4 Control panel sealing head	16
4.5 Indication and commissioning of the 36V charger	17-18
<b>5. Technical data</b>	<b>19</b>
5.1 Strapping system	19-20
5.2 Sealing head	20-21
<b>6. Intended use</b>	<b>22</b>
<b>7. Commissioning</b>	<b>23</b>
7.1 Battery charger	23
7.2 Charging the battery	23-26
7.3 Setting strap width at the sealing head	27
7.4 Switching on the strapping system	28
7.5 Setting the date and time	29-30
7.6 Setting strap tension range at the sealing head	31

7.7	Setting strap tension at the sealing head	32-33
7.8	Setting mode of operation at the sealing head	34-35
7.9	Select favourite	35
7.10	Setting welding time	36
7.11	Changing strap coil	37-45
7.12	Setting pallet width	46
<b>8.</b>	<b>Operation</b>	<b>47</b>
8.1	Strapping	47-51
8.2	Tensioning and sealing of pallets above 70 cm height	52-55
8.3	Sealing control	56
8.4	Tensioning and sealing pallets below 70 cm height with ErgoPack standard Tool-Lift	57-59
<b>9.</b>	<b>Risks</b>	<b>60-63</b>
<b>10.</b>	<b>Service and repair</b>	<b>64</b>
10.1	Cleaning the ChainLance	64
10.2	Replacing the ChainLance	65-69
10.3	Replacing the reversing sledge	70-72
10.4	Replacing individual chain links	73
10.5	Replacing the length adjusting belt	74-75
10.6	Changing the sealing head	76-78
10.7	Changing the control box joystick unit	79-82
10.8	Changing the control box display unit	83-84
10.9	Changing the motor	85-88
10.10	Cleaning/replacing the tension wheel at the sealing head	89-90
10.11	Cleaning/replacing the tooth plate at the sealing head	90
10.12	Replacing the cutter at the sealing head	91
<b>11.</b>	<b>Software Updates</b>	<b>92-94</b>
<b>12.</b>	<b>Spare parts list</b>	<b>95</b>
<b>13.</b>	<b>Personal protective equipment</b>	<b>96</b>
<b>14.</b>	<b>General safety warnings for power tools</b>	<b>97-100</b>

# 1. Validity of the operating instructions

**The operation in these instructions is explained by using the ErgoPack 726X-AGM as an example.**

**All points in these instructions referring to the operation of the sealing head are not applicable as far as the “ErgoPack 700X-AGM” is concerned.**

**These operating instructions are valid for the following models:**

## **ErgoPack 700X-AGM**

Strapping system with electrical drive, electronically controlled via joystick, without sealing head

## **ErgoPack 713X-AGM**

Strapping system with electrical drive, electronically controlled via joystick, with a sealing head for strap width of 9-13mm and a maximum tension force of 1200N

## **ErgoPack 726X-AGM**

Strapping system with electrical drive, electronically controlled via joystick, with a sealing head for strap width of 12-16mm and a maximum tension force of 2500N

## **ErgoPack 745X-AGM**

Strapping system with electrical drive, electronically controlled via joystick, with a sealing head for strap width of 15-19mm and a maximum tension force of 4500N

## 2. General

### 2.1 Moving the strapping system

The strapping system can be pushed in an upright position with the two hand grips (Fig.1). For pushing it you must release the brakes of the two guide rolls on the strap side (Fig.1a).

### 2.2 Parking the strapping system

After having parked the strapping system you have to lock up the brakes of the two guide rolls (Fig.1a) on the strap side to avoid that the system is rolling away accidentally.

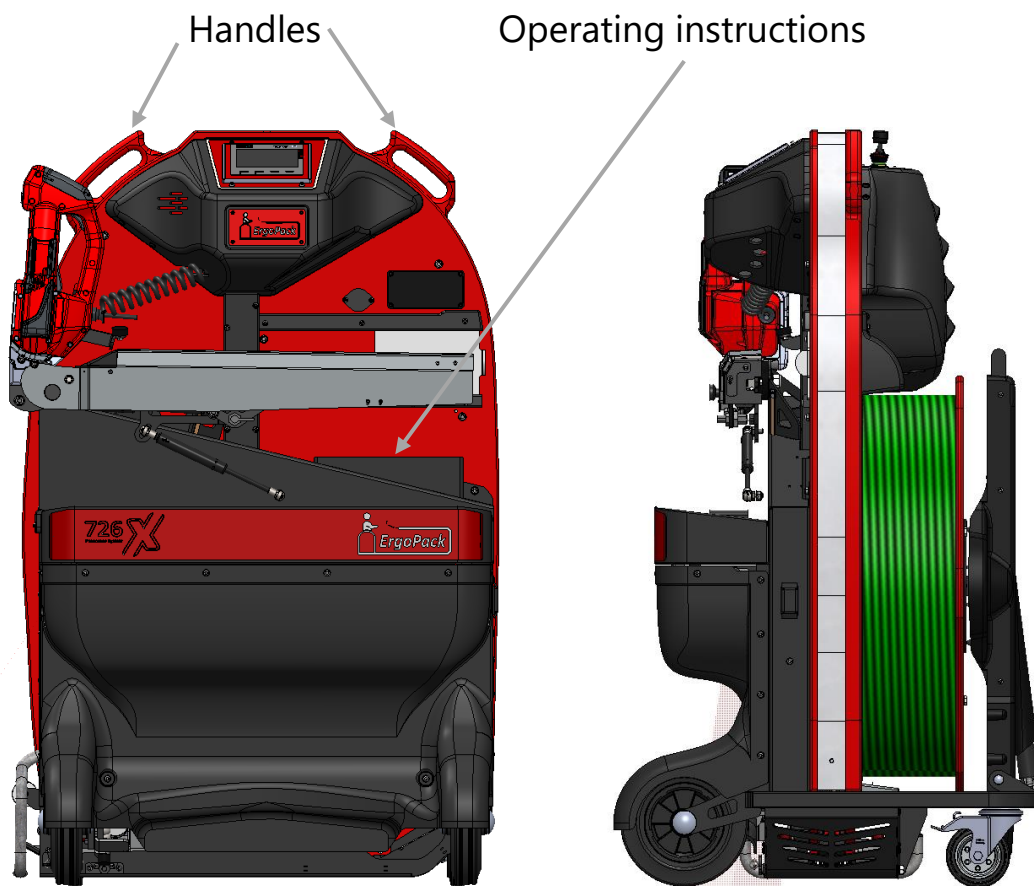

Fig. 1

Fig. 1a

Guide roll with  
parking brake

EN (AGM)

## 2.3 Work area space requirement

For a safe operation while strapping, the system has to be positioned correctly in front of the pallet. Therefore, a free area of at least 1,10 m width in front of the pallet to be strapped is required.

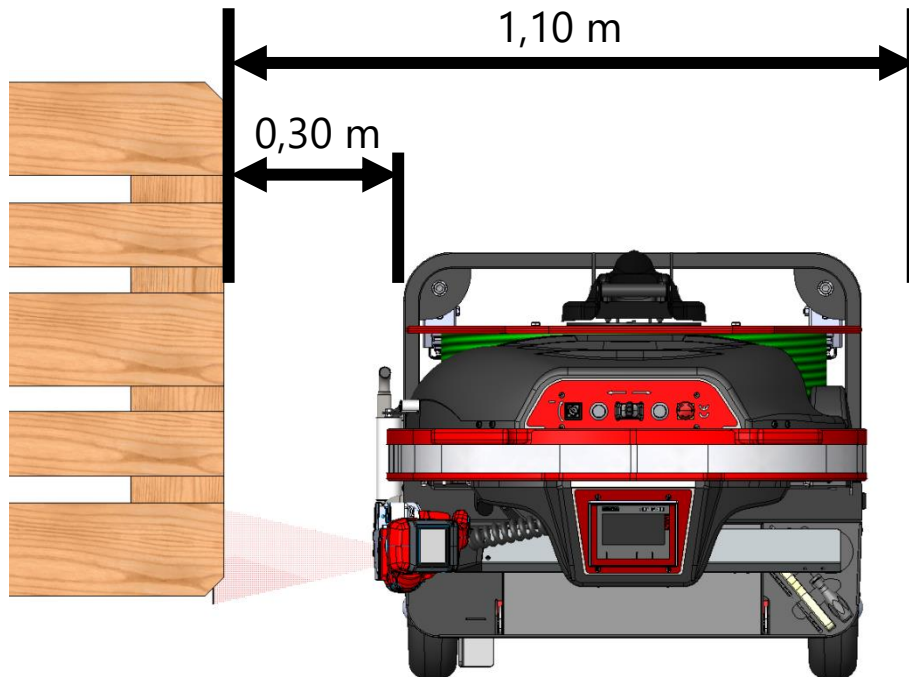

Fig. 2

## 2.4 Environmental conditions

The strapping system is only to be used in a covered dry area, otherwise the risk of an electric shock can not be ruled out.

The ambient temperature during operation must not exceed 50°C and not fall below 0°C.

For the strapping system, an electrically conductive floor is recommended.

## 2.5 Energy supply charger/battery

<b>Charger</b>	3 stage charger
Prim.:	198-264 VAC 50/60 Hz max. 2,0A
Sec.:	44,5V DC/4,5A
Max. power:	200W

<b>Battery pack</b>	3 x 12V AGM battery
Weight	19,5 kg
Charging time:	approx. 10 hours
Operating temperature range:	5°C - 40°C
Number of strappings :	Up to 650 standard strappings* per charge
Life span:	approx. 300 – 500 charges

### **\*standard strapping:**

Battery pack: 100 charging and discharging cycles

Tape: 13mm PET (full strap coil)

Sealing head: 726X, tension force 900N without setting the SOFT tension mode, welding time 2nd range

Pallet: pallet width 0,8 m, pallet height 1,15 m

Strapping speed: fast

Room temperature: 20°C



## 2.6 Notes on environmental protection

Physical or chemical materials injurious to health have not been used for manufacturing the strapping system.

Concerning the waste disposal, valid national rules and regulations have to be considered. Take care about disposing packaging, the product itself and parts accordingly.

The specialist dealer offers disposal according to proper environmental protection.

- Do not open the battery.
- Do not throw the used battery into the domestic waste bin, into fire or into water.

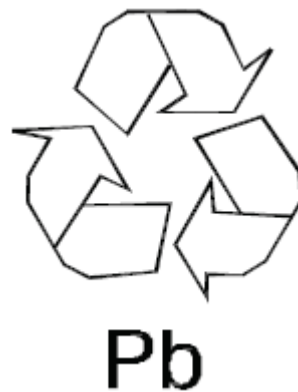

Fig. 3

## 2.7 Meaning of warning symbols, presentation conventions

### 2.8.1 Explanation of symbols



General warning sign

---



Warning against laser radiation

---



Warning of crushing hazards

---



Do not operate for persons with pacemakers or implanted defibrillators.

---



Compliant with the relevant European directives

---



Symbol for lead batteries (contains recyclable material).

---

Pb



Do not dispose of in household waste

---

Pb



Follow instructions

## 2.8.2 Explanation of the safety representation



### **Warning!**

Marks a hazard with moderate risk.  
If not avoided, it can result in death or serious injury.

---



### **Caution!**

Marks a hazard with a minor risk.  
If not avoided, it can result in a minor or moderate injury.

---



### **Attention!**

Marks a situation to be considered.  
If not considered, it can lead to material damage or poor operating results.

---



### **Note!**

Marks useful, additional information.

---

# 3. Recommendations for protective measures

These operating instructions will help you to understand the strapping system and how to use it according to regulations. The operating instructions contain important notes on how to use the strapping system safely, properly and economically.

Adhering to the notes helps you to avoid dangers, repairs and down times and also increases the reliability and life span of the strapping system.



## **Note!**

The operating instructions must be available at the place where the strapping system is used (below the sliding window, Fig. 1).

Before using the strapping system for the first time, the operating instructions have to be read, understood and used by everybody who works with the system. These works include operation, maintenance and repair!

See chapter 13 and chapter 14.

In addition to the operating instructions and the rules in the country and place of use for the prevention of accidents, the recognized special rules for working safely and according to proper and professional standards also have to be respected.

In order to protect the strapping system against unauthorized access, it is recommended to remove the key from the main switch and disconnect the power supply from the battery pack.

The key should be kept safe from unauthorized access.

## 3.1 Safety regulations for battery and charger

- Check the plug and the cable before each use and have them replaced by a specialist if they are damaged.
- The charger is intended only for the batteries supplied with the strapping system. Do not charge any batteries from other manufacturers, use original spare parts only.
- Protect the charger and battery against moisture; operate them in dry rooms only.
- Do not open the battery and protect it from shock, heat and fire. Danger of explosion!
- Store batteries in a dry frost-proof place. The ambient temperature must not exceed +50°C and must not fall below -5°C.
- Damaged batteries may not be reused and must be disposed of properly.



### **Note!**

- Keep the connection plug of the charger and the ErgoPack system away from non-related objects and dirt.
- Plug and socket of battery, charger and power cable have a magnetic connection. There is a risk that metallic particles, such as e.g. filing or drilling chips or similar, adhere and may lead to damage of the contacts.
- Plug and socket should therefore be kept away from metallic particles and regularly checked for the adhesion of such particles. For cleaning, it is best to use compressed air in conjunction with a brush with synthetic bristles.

# 4. Description

## 4.1 Design



Fig. 4



Fig. 5

- Control panel
- Safety cutter
- Strap brake
- Control display



Fig. 6



Fig. 7

- Sealing head
- Sliding window with safety switch
- Operating instructions
- Tool-Lift
- Covering of battery box

## 4.2 Control panel strapping system

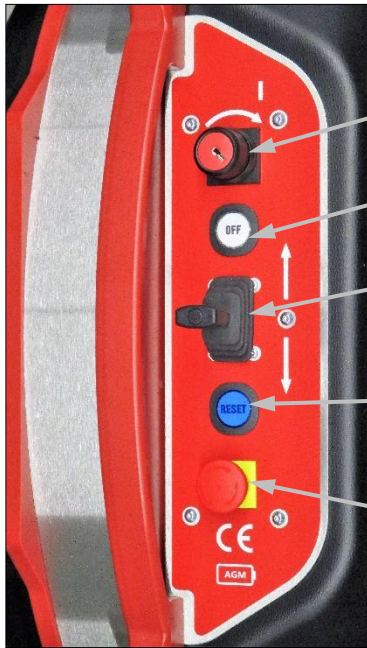

**Main switch** (power supply 0/1)

**OFF switch** (disconnects the power supply)

**Joystick** (moving the ChainLance in and out with precision speed control)

**Reset switch** (function check while switching on and acknowledging of malfunctions)

**EMERGENCY STOP switch** (stops the strapping system)

Fig. 8

## 4.3 Touch display strapping system



Fig. 9

**Touch display** for setting all parameters at the strapping system, such as pallet width.

**Function key F1 – F4:**

- F2 Strap coil changing mode
- F3 Menu

## 4.4 Control panel sealing head

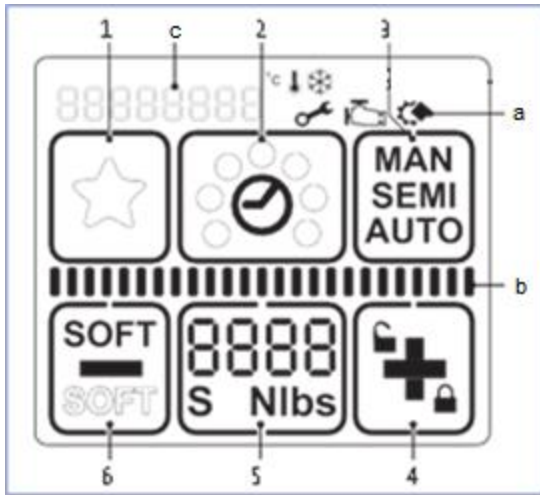

Fig. 10

- 1 „Favourite“
- 2 „Welding time“
- 3 „Operating mode“
- 4 „Plus & Keylock“
- 5 „Tension force“
- 6 „Minus & Soft tension“
- a „Information symbols“
- b Status indicator bar  
„Tensioning/Welding“
- c Display „Messages“



Display activated.



Welding process is finished, tool can be removed.

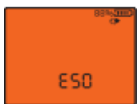

Application error: Temporary system error, can be rectified by the operator.



Tool fault: static system error, rectify error. If the error cannot be rectified -> ErgoPack service partner



## 4.5 Indication and commissioning of the 36V charger

Inside the red battery housing there are 3 x 12V AGM batteries installed and connected in series. The ErgoPack 36V charger charges these batteries.

The green or yellow shining LED indication light on the 36V charger indicates different operating states of the charger as well as the charging status of the battery pack.

1.) Once the charger is plugged into the main power supply, the charging process starts immediately, which will be indicated by a yellow shining LED indication light, regardless of whether a battery pack is connected or not.

2.) You can now connect the battery pack to the charger. The charging process starts again, thereby the yellow LED indication light remains yellow. The batteries will be charged.

3.) As soon the LED indication light shines green, the charging process is finished, the batteries are fully charged and the charger switches into preserving mode. An overcharging of the batteries is not possible.

4.) By disconnecting the battery pack from the charger, the LED indication light remains green and indicates then the operational readiness of the charger.

5.) A new charging process starts when the battery pack will be connected again, the LED indication light shines yellow again until the batteries are fully charged and switches afterwards to green as well.

6.) As long as the charger remains plugged in the main power supply, the steps described in point 5.) are performed. If the charger will be removed from the main power supply and plugged in again, firstly the steps described in point 1.) and afterwards the next steps will follow.

**Do not remove the battery pack from the charger during the charging process!**



## Attention!

The charging time is approx. 10 hours. The battery pack is only fully charged when the LED indication light on the charger is permanently shining green!

LED indication light

Automotive flat fuse 10A/32V



Fig. 11

Orange → 4,5A  
Yellow → 44,5V  
Green → 41,4V  
(Ready/Standby)

# 5. Technical data

## 5.1 Strapping system

### Dimensions (all types)

Length 665 mm  
Width 770 mm  
Height 1200 mm

### Weight (without optional equipment):

ErgoPack 700X (incl. battery) 106 kg  
ErgoPack 713X (incl. battery) 114 kg  
ErgoPack 726X/745X (incl. battery) 115 kg

### Maximum chain speeds:

#### **Slow, strapping**

Moving out horizontally: 27 m/min  
Moving out vertically: 53 m/min  
Moving in vertically: 52 m/min  
Moving in horizontally: 39 m/min

#### **Medium, strapping**

Moving out horizontally: 29 m/min  
Moving out vertically: 58 m/min  
Moving in vertically: 57 m/min  
Moving in horizontally: 45 m/min

#### **Fast, strapping**

Moving out horizontally: 66 m/min  
Moving out vertically: 78 m/min  
Moving in vertically: 76 m/min  
Moving in horizontally: 65 m/min

### **Strap changing:** setting up/threading in strap

Moving out: 10 m/min  
Moving in: 8 m/min

### **Max. Chain thrust:**

310 N

**Plastic strap**

Strap materials

Polypropylene (PP)

Polyester (PET)

**Strap width**

713X, adjustable to

9-10 mm / 12-13 mm

726X, adjustable to

12-13 mm / 15-16 mm

745X, adjustable to

15-16 mm / 18-19 mm

**Strap thickness**

713X

0,40-0,80 mm (PET)

0,50-0,80 mm (PP)

726X

0,50-1,00 mm (PET/PP)

745X

0,80-1,30 mm (PET/PP)

## 5.2 Sealing head

**Weight:**

(incl. spiral cable)

3,8 – 4,3 kg\*

**Dimension**

(incl. spiral cable)

length 335 mm

width 140 mm

height 180 mm

**Tension**

713X

150-1200 N

726X

400-2500 N

745X

400-4500 N

**Tensioning speed**

290 mm/s (713X)

220 mm/s (726X)

120 mm/s (745X)

**Sealing**

friction-weld sealing

\*depending on the type used

## Measured A-graded

noise emission level

(EN ISO 11202)

(EN 60745-1/2:2009)

713X	L <sub>pA</sub>	79 dB (A)	L <sub>pAeq</sub>	77 dB (A)
726X	L <sub>pA</sub>	78 dB (A)	L <sub>pAeq</sub>	82 dB (A)
745X	L <sub>pA</sub>	79 dB (A)	L <sub>pAeq</sub>	81 dB (A)

## Sound power level, on average

(EN 60745 -1/2:2009)

713X	LW <sup>Aeq</sup>	88 dB (A)
726X	LW <sup>Aeq</sup>	93 dB (A)
745X	LW <sup>Aeq</sup>	92 dB (A)

## Measurement inaccuracy K

713X	3,0 dB (A)
726X	3,0 dB (A)
745X	3,0 dB (A)

## Hand arm vibrations without using a Tool-lift

(EN 60745-1/2:2009)

713X	a 2,4 ms <sup>-2</sup>
726X	a 2,4 ms <sup>-2</sup>
745X	a 2,3 ms <sup>-2</sup>

## Measurement inaccuracy K

713X	1,5 ms <sup>-2</sup>
726X	1,5 ms <sup>-2</sup>
745X	1,5 ms <sup>-2</sup>

## 6. Intended use

The strapping system is designed for strapping pallets (machine assisted hand strapping). It has been designed and built for safe and ergonomic operation during strapping.

The strapping system is only suitable for strapping with plastic straps (polypropylene PP and polyester PET). Strapping with steel strapping is not possible with this strapping system.

The strapping system is not designed for strapping open and unpacked food products.

Strapping of flammable products (highly flammable, explosive see table of hazardous substances) is only possible in suitable outer packaging.

The set tension force must correspond to the packaged goods to be strapped. Constructing the strapping system there was not considered any risk due to damaging of dangerous products or their package.

The strapping system is not designed for strapping in areas with explosive atmospheres (ATEX areas).

Strapping generates electrostatic charges. These can be reduced by a relative humidity of more than 45% and by a conductive or electrostatically dissipative floor (dissipation resistance less than  $10^9 \Omega$ ).

The strapping system is not suitable for operation by persons with implants such as pacemakers or defibrillators.

# 7. Commissioning



## **Attention!**

Before using the strapping system for the first time, a visual inspection for exterior damages has to be done.

## 7.1 Battery charger

The main voltage must comply with the details on the type plate.  
The charger is only suitable for charging the delivered 36V battery pack.

## 7.2 Charging the battery pack

- 1.) Connect charger to the main voltage
- 2.) Open cover of battery case (by pulling at the outer corners as shown below).



Fig. 12

3.) Disconnect the plug (13a) from the battery pack (14a) and let the cable hang freely down.



Fig. 13

13a

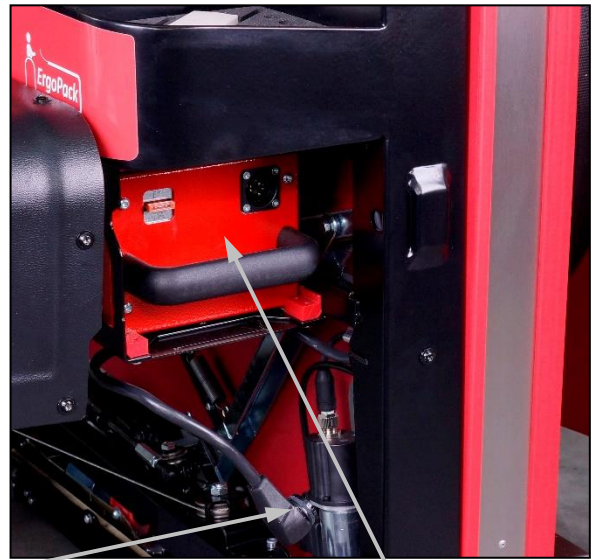

Fig. 14

14a



**Warning!**

Charge the battery pack only with the ErgoPack 36V charger through the charging socket!

4.) Insert the plug of the 36V charger (16a) into the socket (15a) of the battery pack.



Fig. 15

15b

15a



Fig. 16

16a



**Attention!**

Replace always defective flat fuses (15b) of the battery pack (see Fig.15) by a new one of the same type (vehicle blade fuse 30A / 80V). If necessary, contact your ErgoPack service partner.



5.) Alternatively, the battery pack can be also removed from the strapping system ...



Fig. 17

... or be comfortably pulled out to the battery trolley (optional equipment)...



Fig. 18



Fig. 19

... and be replaced by a previously charged battery pack.



Fig. 20



### **Attention!**

The charging time is approximately 10 hours. The battery pack is only fully charged when the LED indication light on the charger is permanently shining green!

The maximum charging current flows if the temperature of the battery is between +5°C and +40°C. Avoid battery temperatures below 0°C while charging.



### **Note!**

During charging, the battery pack always has to be in a horizontal position (cover always upside). Never place the battery pack in lateral or upright position.

You achieve the longest life span, if the battery pack is always charged immediately after it was used and if it is only stored fully charged.

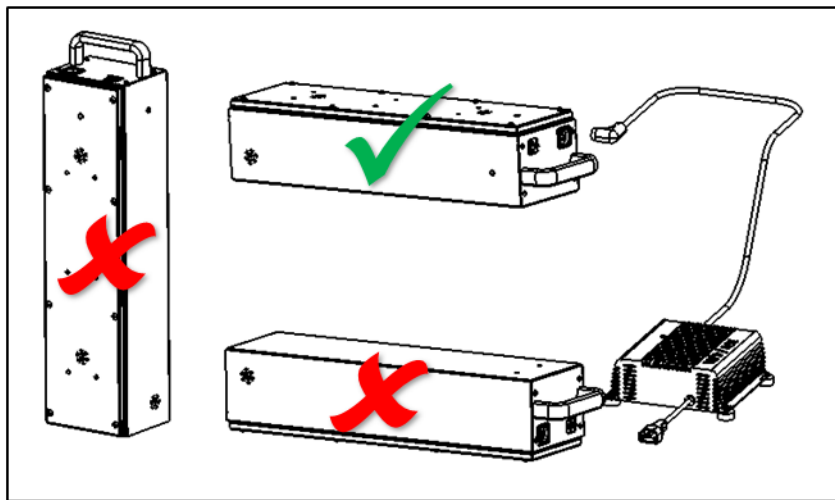

Fig. 21

# 7.3 Setting strap width at the sealing head

The sealing head can be used with different strap widths:

ErgoPack 713X	9-10 mm or 12-13 mm
ErgoPack 726X	12-13 mm or 15-16 mm
ErgoPack 745X	15-16 mm or 18-19 mm

The setting of the strap width is explained using the example of model 726X. The setting of the strap width with the models 713X from 9-10 mm to 12-13mm and 745X from 15-16mm to 18-19mm works accordingly.

## a) Change strap width from 12–13 mm to 15–16 mm

- Switch the strapping system off
- Release three cylinder screws Torx (6). Lift the rocker lever towards the handle, release cylinder screw Torx (7) and remove strap guide rear 13mm (8).
- Remove side cover (5).
- Release counter-sunk screw Torx (2) and remove strap guide front 13 mm (1).
- Release counter-sunk screw Torx (4) and remove strap guide front 13 mm (3).
- Release cylinder screw Torx (10) and remove strap guide rear 13 mm (9).
- Fit side cover (5) (secure cylinder screw with screw locking varnish "medium-tight". Install strap guide rear 16 mm (8).

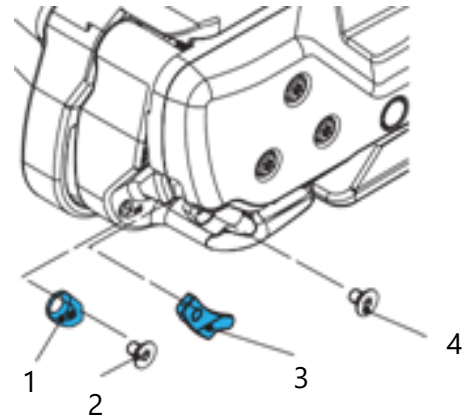

Fig. 22

## b) Change strap width from 15-16mm to 12-13 mm

- Release three cylinder screws Torx (6). Lift the rocker lever towards the handle, release cylinder screw Torx (7) and remove trap guide rear 16 mm (8).
- Remove side cover (5).
- Fit strap guide front 13 mm (1) (secure counter-sunk screw with screw locking varnish "medium-tight").
- Fit strap guide front 13 mm (3) (secure counter-sunk screw with screw locking varnish "medium-tight").
- Fit strap guide rear 13 mm (9) (secure cylinder screw with screw locking varnish "medium-tight").
- Fit side cover (5) (secure cylinder screw with screw locking varnish "medium-tight"). Install strap guide rear 13 mm (8).

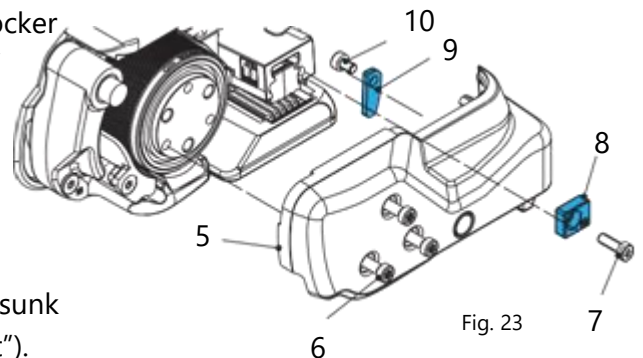

Fig. 23

## 7.4 Switching on the strapping system

### Instructions:

- Charge the battery pack as described under 7.2.
- Plug in the connector of the power cable (24a) into the socket of the battery pack (24b).
- Close the cover of the battery case.
- Make sure that the EMERGENCY STOP switch (25a) is not pressed. If necessary, unlock it by turning.
- Turn the main switch (25d) to the right to operating mode "1" and hold it in this position for approximately 2 seconds.



Fig. 24

24a 24b



Fig. 25

25a 25b 25c 25d

- Follow the instructions on the display after the "ErgoPack" logo disappeared (after approx. 45 seconds).

## 7.5 Setting the date and time



### **Attention!**

The date and time may only be set by trained, instructed personnel. You can obtain the required access code from your ErgoPack service partner.

#### 1. Step:

Check the time in the display in the main menu at the top left.

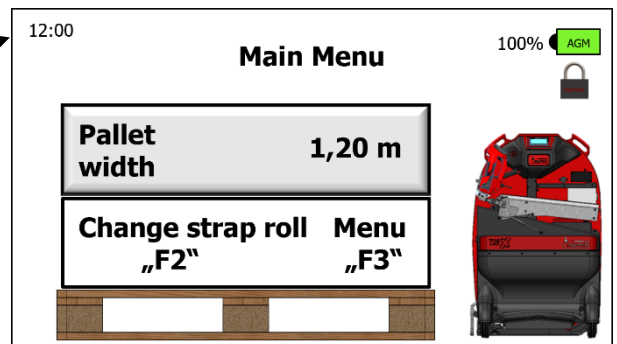

Fig. 26

#### 2. Step:

Press the "F3" button (1) on the display and press repeatedly on "Next" (2) until menu page 8 (3) appears.

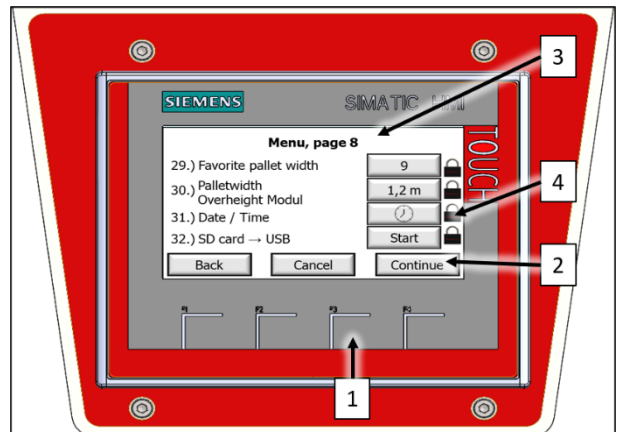

Fig. 27

#### 3. Step:

Press the "Clock" button (4) in menu line 31.).

#### 4. Step:

Unlock the lock with the corresponding access code.

5. Step:

Check the date.

Year, month and day can each be set with the "+/-" button.

Then confirm the set date with the "Store" button.

If the date does not need to be set, you can switch to setting the time by pressing the "Store" button.

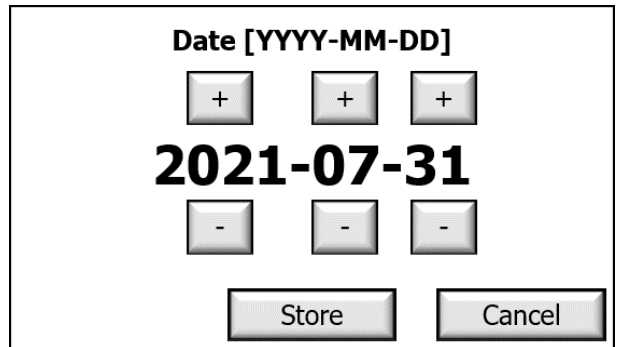

Fig. 28

6. Step:

Check the time.

Hour and minute can each be set with the "+/-" button.

Then confirm the time with the "Store" button.

If the time does not need to be set, the date/time setting can be saved by pressing the "Store" button.

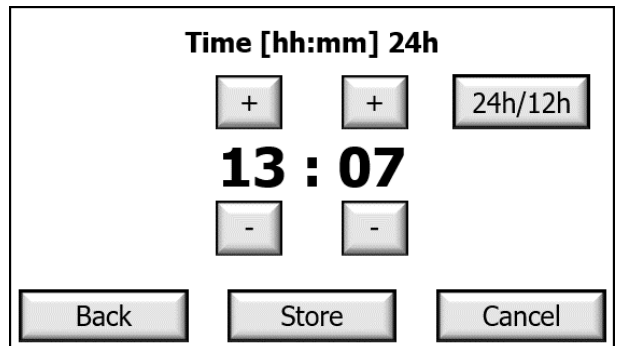

Fig. 29

Press the "24h/12h" button to switch between 24-hour or 12-hour format.

## 7.6 Setting strap tension range at the sealing head

Two strap tension ranges can be set at the sealing head:

**NORMAL** = Standard tension range for PET strap

713X = 400-1200 N

726X = 900-2500 N

745X = 1300-4500 N

**SOFT** = Soft tension range for PP strap

713X = 150-750 N

726X = 400-1360 N

745X = 400-1600 N

Press „Soft“ button (a).

The soft mode **is deactivated** when the „SOFT“ display (b) changes position and is shown outlined.



Press „Soft“ button (a).

The soft mode **is activated** when the „SOFT“ display (c) changes position and is shown in bold. The displayed tension force is reduced correspondingly.

On the left under the tension force an "S" (d) also appears.

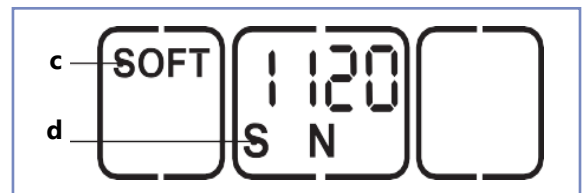

Fig. 30



### **Attention!**

Always use the SOFT tension mode when working with PP-strap!

By using the Soft mode, the tension wheel accelerates more slowly and avoids excessive strap waste when sealing with PP strap.

## 7.7 Setting strap tension at the sealing head

The set tension force is displayed continuously when the tool is ready for operation.

Press „tension force“ button (2).

- The set tension force flashes for 5 seconds.
  - The buttons + (1) and – (3) appear.
  - Unused displays disappear.
- Press + (1) or – (3) button until the required tension force is displayed.
- The status indicator bar (4) shows the set tension force in relation to the possible maximum value.
- Save: Press „tension force“ button (2) or wait for 5 seconds.

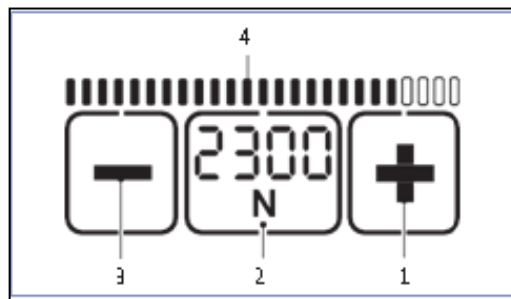

Fig. 31



### **Note!**

- Switch between display in „N“ or „lbf“: Press the flashing „tension force“ button (2) for two seconds.
- Every time the button is pressed an acoustic signal confirms the action.
- The tension force is displayed continuously when the tool is operational.
- Setting soft tension (section 7.6).



<b>713X</b>										
Standard	N*	400	500	600	700	800	900	1000	1100	1200
	lbf*	90	110	135	155	180	200	225	250	270
Soft	N	150	225	300	375	450	525	600	675	750
	lbf	33	50	67	85	100	120	135	150	165

<b>726X</b>										
Standard	N*	900	1100	1300	1500	1700	1900	2100	2300	2500
	lbf*	200	250	290	340	380	430	470	520	560
Soft	N	400	520	640	760	880	1000	1120	1240	1360
	lbf	90	115	145	170	200	225	250	280	305

<b>745X</b>										
Standard	N*	1300	1700	2100	2500	2900	3300	3700	4100	4500
	lbf*	290	380	470	560	650	740	830	920	1000
Soft	N	400	550	700	850	1000	1150	1300	1450	1600
	lbf	90	120	160	190	225	260	290	325	360

(rounded values)

\* N = Newton, lbf = pound-force per square inch



**Warning!**

Adjusted tension force must relate to the packaged goods to be strapped.

Possible hazards caused by damages of dangerous goods or their packaging are not considered with the design of the strapping system.

## 7.8 Setting mode of operation at the sealing head

Press „Operating mode“ (1) button.

- Unused displays disappear.
- The currently set operating mode flashes for 5 seconds.
- + and – appear.

Press button + (2) or – (3) until the required operating mode is displayed.

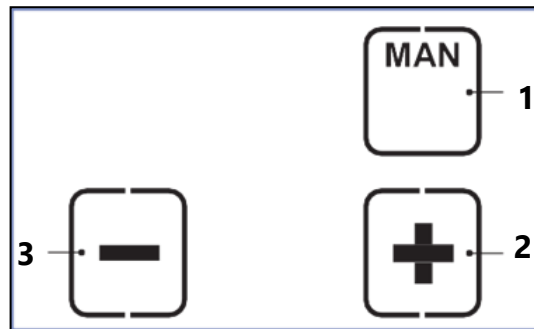

Fig. 32

### **MAN/ SEMI/ AUTO**

By pressing the „Operating mode“ button (1) again, or after waiting 5 seconds, the set mode is saved. Each operating mode can also be selected for the tension range „Soft tension“ (Section 7.6).

- **MAN = Manual**

The tensioning button must be pulled and held until the desired strap tension has been reached. The welding button must then be briefly pressed so that the straps are welded and the upper strap is cut off.

- **SEMI = Semi-automatic strapping (standard/factory setting)**

The tensioning button must be pulled and held until the set tension force has been reached. The straps are then automatically welded and the upper strap is cut off. It can be welded manually at any time by pressing the welding button.

- **AUTO = Fully automatic strapping\***

The tensioning button has to be pulled (touched) once only. This triggers the tensioning process. Once the set tension force has been reached, the straps are automatically welded and the upper strap is cut off.

\* This operating mode AUTO = Fully automatic strapping is factory blocked! Activation only through your ErgoPack service partner possible.



**Warning!**

**Strap tensioning or strapping, danger of jamming and crushing**

Do not place hands or other body parts between the strap and the packaged goods during the strapping process. Ensure that there are no other persons in the hazard zone.

**For an emergency stop in the case of danger (trapped person):**

To release the strap tension (before welding), pull the rocker lever. In operating mode AUTO, also the tensioning or welding button can be pressed again. After welding, cut the strap using a tool (strap cutter).

## 7.9 Select favourite\*

The function „favourite“ activates a second settings level, whose parameters can be set freely like those of the main level. This enables the operator to quickly change from one setting into the other.

**Deactivate favourite:**

- Press „favourite“ button (1).  
The star (2) changes from bold to outlined. All parameters change to the pre-set values of this settings level.

**Activate favourite:**

- Press „favourite“ button (1). The star (3) changes from outlined to bold. All parameters change to the pre-set values of this settings level.

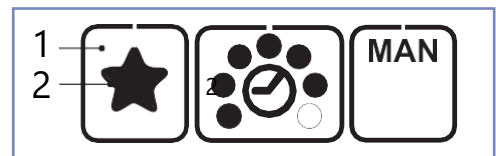

Fig. 33 a

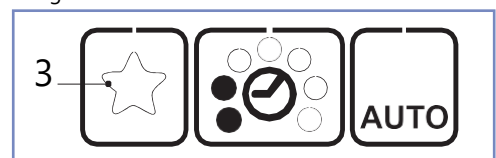

Fig. 33 b

\* The operating mode favourite is factory blocked! Activation only through your ErgoPack service partner possible.

## 7.10 Setting welding time

The set welding time is displayed always by filled dots, when the system is ready for operation.

- Press „welding time“ button (2).
  - Unused displays disappear.
  - The filled dots of the current set welding time flash for 5 seconds.
  - + and – appear.
- Press button + (1) or – (3) until the required welding time appears.
- Save: Press „welding time“ button (2) or wait for 5 seconds.

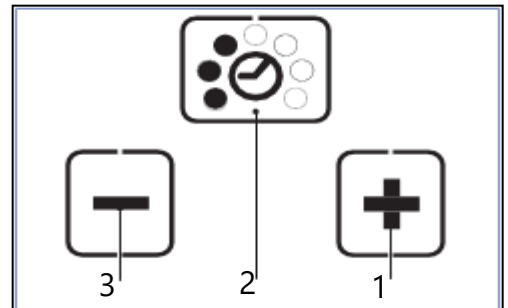

Fig. 34

## 7.11 Changing strap coil

Switch on the strapping system as described in section 7.4

For changing the strap coil press „F2” button (35a) and follow the instructions appearing on the display.



Fig. 35

35a

By pressing „next” button, **1. Step** appears on the display.

### 1. Step

By pressing the „Positioning ChainLance” button, the ChainLance will automatically reach the correct position so that the red chain link stops in the middle of the sliding window.

**For this process the sliding window must be closed!**

Once the ChainLance reached the right position, the **2. Step** appears automatically.



### **Note!**

By pressing the „Stop” button the strap coil changing mode can be stopped at any time and you will get back to the main menu.

## 2. Step

Open the sliding window (36a).  
After opening the sliding window, **3. Step** appears automatically.

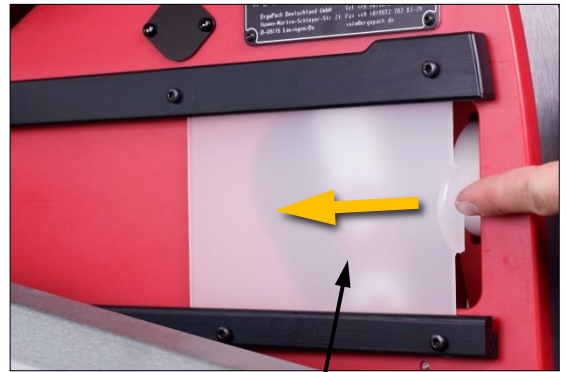

Fig. 36

36a

## 3. Step

Fold down the pivot arm with the red circular disk until its final stop.



Fig. 37

Place a new strap coil onto the red circular disk, that the strap uncoils in the **counter-clockwise direction** when looking down on the roll.



Fig. 38



### **Note!**

Do not yet remove the tape or adhesive tape, which fix the strap on the coil!

Fold up the arm with the strap coil again in its vertical position as shown on the picture.



Fig. 39

Now, remove the tapes or adhesive tapes fixing the strap on the coil.

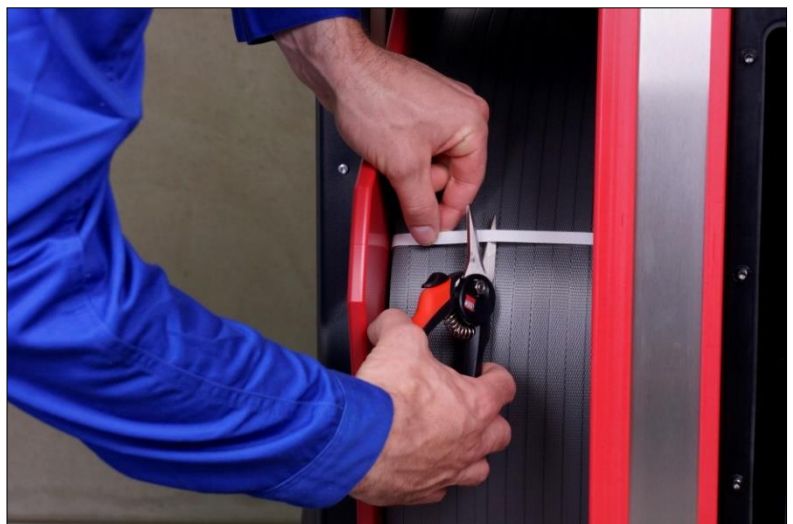

Fig. 40



**Attention!**

Remove adhesive tapes from the strap coil **completely**. Adhesive residues remaining on the strap coil may stick inside the strapping system and lead to malfunctions.

Fold up the cover of the white roll for strap infeed, thread the strap through the U-bolt...



Fig. 41

...and over the white roll to the inside. Thereafter fold the cover back down again.



Fig. 42



Fig. 43

After pressing „Next“ on the touch display you will finish the 3. Step and get to the **4. Step.**

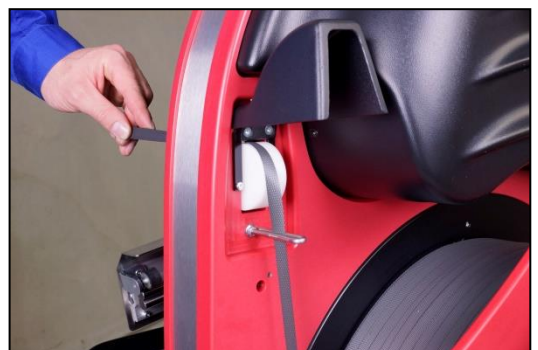

Fig. 44



#### 4. Step

Press from the left hand side on the metal clamp lock located in the red chain link...



Fig. 45

...then slide the strap from the right to the left through the slot in the clamp lock.



Fig. 46



Fig. 47

To finish the 4. Step, the sliding window has to be closed.



Fig. 48

## 5. Step

Press the „Positioning ChainLance“ button until the ChainLance stops automatically and the **6. Step** appears.



Fig. 49

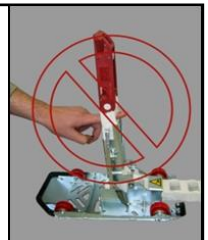

Fig. 50



**Warning, risk of injury!**

Never put your fingers between the chain links.



## 6. Step

Remove the strap from the clamp lock of the red chain link and hold it straight up as shown (Fig. 53).

Thereafter, press the „Retract chain“ button until the ChainLance stops and the **7. Step** appears.



Fig. 51



Fig. 53



Fig. 52



**Warning, risk of injury!**

Never put your fingers between the chain links.



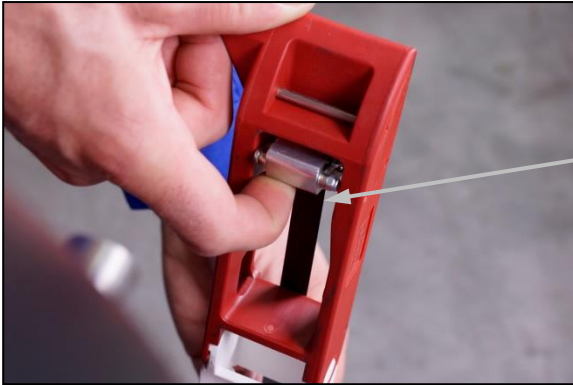

Fig. 54

### 7. Step

Open the eccentric latch in the red head piece of the ChainLance by pushing it inwards with your finger. (Fig. 54)

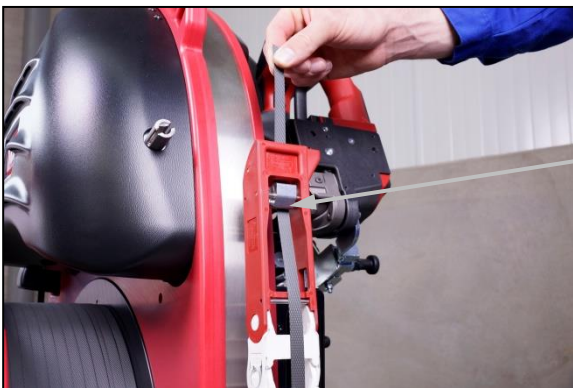

Fig. 55

Push the strap from the back through the head piece of the ChainLance (as shown).

The strap must pass between the two aluminium eccentrics.



**Warning, risk of injury!**

Never put your fingers between the chain links.





Fig. 56

Move the reversing sledge completely backwards by pressing the „Retract ChainLance“ button. Afterwards you will get back to the **main menu**.



**Attention!**

Make sure that the strap remains continuously tensioned while moving back the ChainLance, to avoid the strap being pushed into the strapping system.



Fig. 57

Place the overlapping strap with a loop through the small slot underneath the left handle (as shown).

# 7.12 Setting pallet width

## 1. Step:

To set the correct pallet width, press the „Pallet width“ button in the main menu.

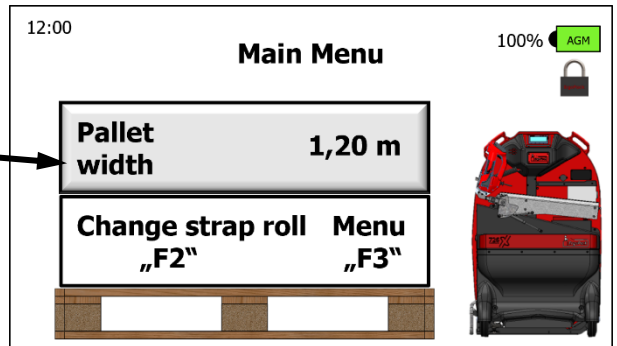

Fig. 58

## 2. Step:

You can choose the required width of the pallet to be strapped among the factory set pallet widths. In case the required pallet width is not listed, you can adjust one of these buttons to the required pallet width.



Fig. 59

For changing one of the buttons to the required pallet width, proceed as follows:

Press and hold the button to be changed for approx. 3 seconds. You can then set the required pallet width in 10 cm steps (Fig. 60). As soon as you confirm your setting with „OK“, this new pallet width will be saved in the preset pallet widths.

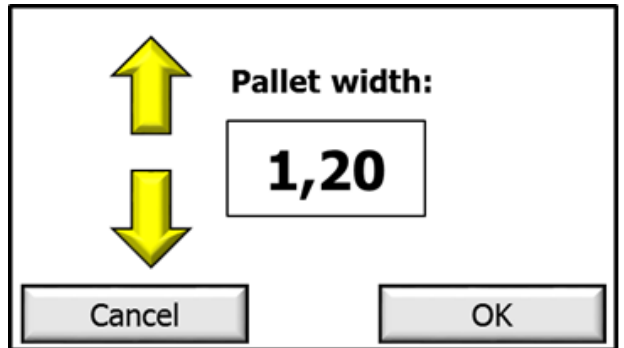

Fig. 60

Your ErgoPack is now ready for strapping.

# 8. Operation

## 8.1 Strapping

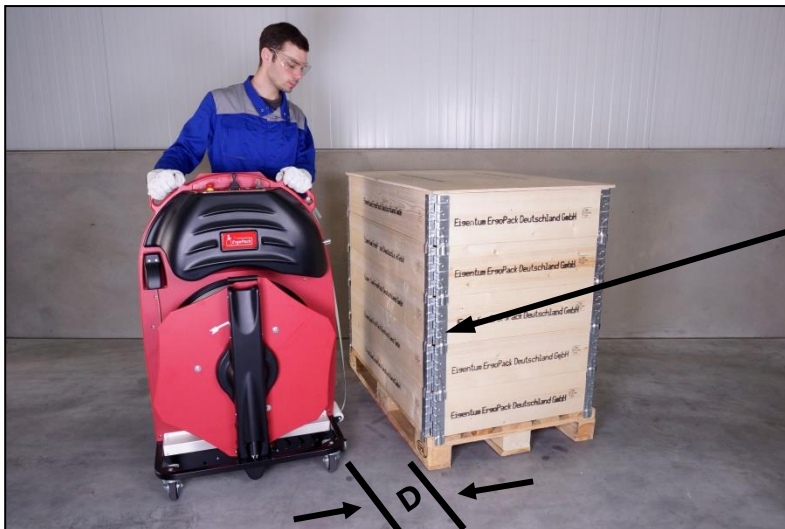

Fig. 61

### 1. Step

Place the ErgoPack at a distance of approx. 30 cm (D) in front of the pallet to be strapped.

**If your system is equipped with the optional line laser:**

Align the ErgoPack parallel to the pallet so that the laser line runs alongside the pallet edge.



Fig. 62

### 2. Step

Move out the ChainLance by pushing the joystick in „move out“ direction.

The reversing sledge leads the strap through and underneath the pallet...



... and back up again on the opposite side.

Fig. 63



If the setting of the pallet width and the positioning of the strapping system are correct, the distance between the chain and the pallet is about 10 cm.

Fig. 64



**Attention!**

Push the joystick until the ChainLance appears on the other side and falls in your direction.

Release the joystick, so that it returns to the neutral position (central position) and stops the ChainLance moving out further.

Catch the ChainLance as shown at the red head piece. Do not let the ChainLance drop onto the package!





### 3. Step

Hold the strap with your left hand as shown, **directly at the head piece of the ChainLance...**

Fig. 65



... move the ChainLance completely back by pushing the joystick in „move in“ direction.

Fig. 66



### **Attention!**

Always keep the strap slightly under tension when moving the ChainLance backwards, to avoid that loops can be formed at the reversing sledge. Loops may lead to malfunctions while moving back the ChainLance.

#### 4. Step

The strap lifter comes up automatically when the reversing sledge moves back into the strapping system.

**Now you have to loose the strap tension of your left hand; otherwise the strap lifter will not be able to come up.**

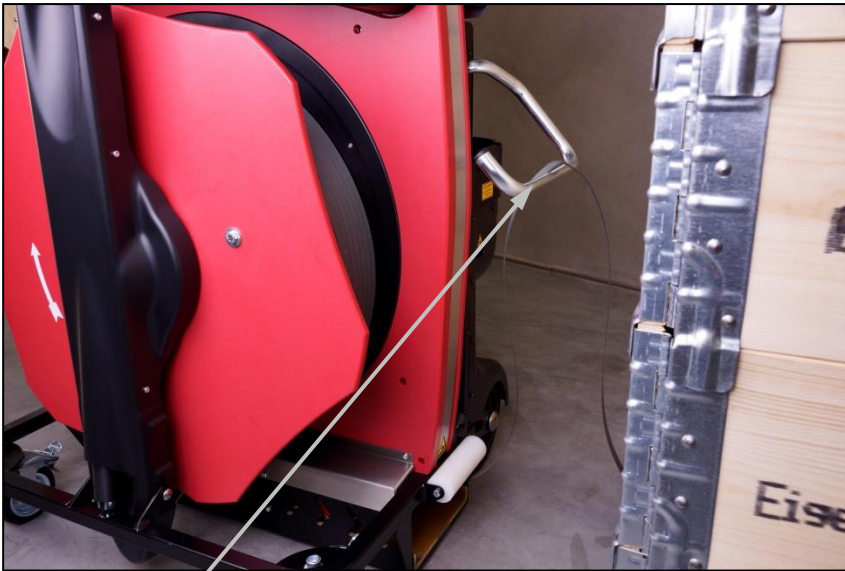

Fig. 67

The strap lifter lifts the second end of the strap up to working height so you can grasp it without bending down.

Only keep the joystick pushed until the strap lifter is fully in its upper position.

The time, how long the strap lifter should remain in its upper position, can be set in „page 3“ of the menu.



#### ***Attention!***

**You have to hold the strap loosely in your hand when the strap lifter comes up.**

The strapping system automatically switches off to prevent damages if you do not let go of the strap when the strap lifter rises. The strap lifter can be raised up again by pushing the joystick in the „move in“ direction twice.



Fig. 68

If for sealing the strap you have to pull some additional strap out of the strapping system, do not take the strap directly at the strap lifter...

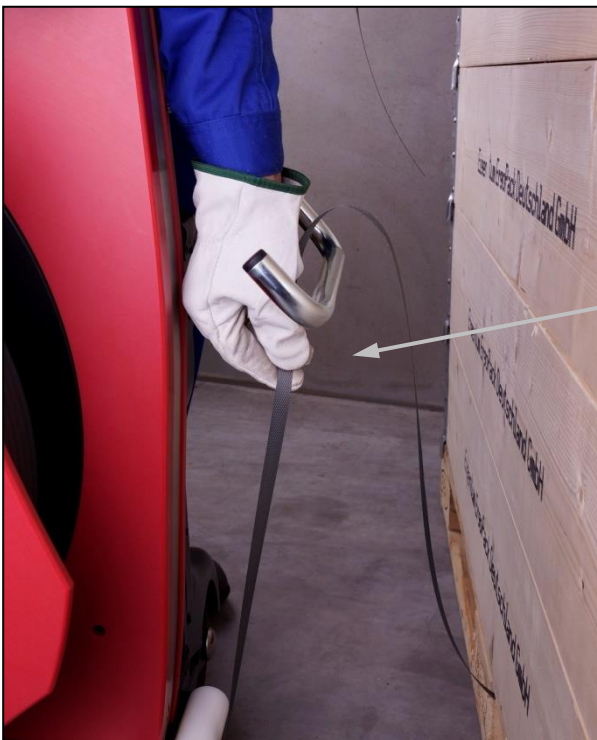

Fig. 69

...but about 10cm below the strap lifter. Hold the strap with the whole hand and pull it out of the strapping system. At the same time, you have to let the end of the strap slide through your other hand!

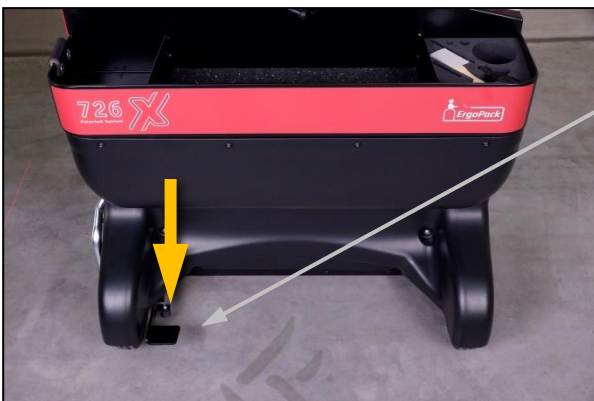

Fig. 70

**If your strapping system is equipped with the optional strap break relief:**

Before pulling at the strap, press down the foot pedal at the left side. This reduces the brake force of the strap coil and eases pulling out strap a lot.

## 8.2 Tensioning and sealing of pallets **above** 70 cm height

### 1. Step

Strap the pallet as described in section 8.1

### 2. Step

Overlap the straps so that the end of the strap lies underneath.

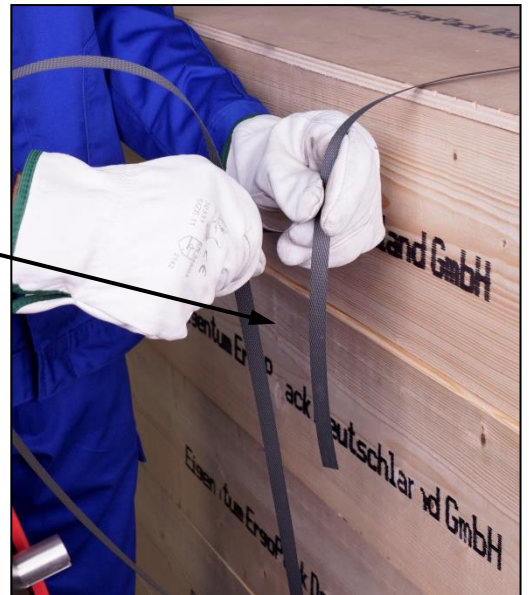

Fig. 71

### 3. Step

Hold then both straps as shown with the **right hand**.

The end of the strap should lie in your hand and not project beyond it!



Fig. 72

#### 4. Step

Push the sealing head towards the pallet with the left hand and tilt it forward at the same time so that the sealing head is parallel to the package.

Pull the rocker lever to open the clamp of the sealing head.



Fig. 73

With your right hand you can now feed the strap from the top to the bottom through the slot in the sealing head (similar to a credit card).

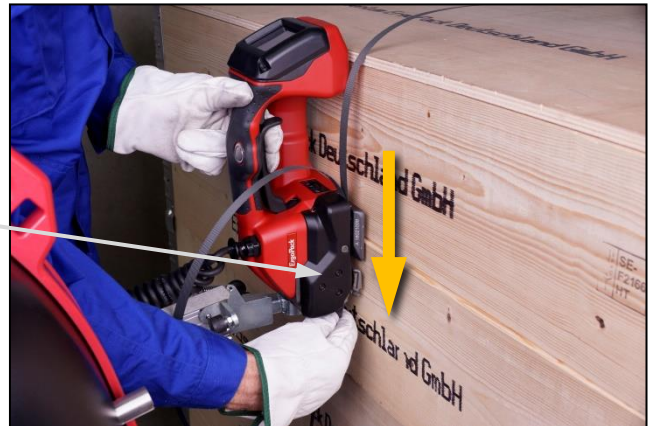

Fig. 74

Now let go of the rocker lever.



Fig. 75

## 5. Step

The tensioning and sealing of the strap is different according to the set mode (manual, semi-automatic or automatic mode) (see also section 7.8).

### 5.1 Manual tensioning and sealing

Pull the tensioning button (Fig. 76) until the required tension force is reached (see also section 7.7).

Thereafter, press the round welding button (Fig. 77) to weld both straps and to cut off the upper one.

### 5.2 SEMI-Semi-automatic tensioning and sealing

Pull the tensioning button (Fig. 76) until the pre-set tension force is reached. Afterwards, both straps will be automatically welded and the upper strap will be cut off. You can also weld the straps manually at any time by pressing the welding button even if the pre-set tension force was not reached.

### 5.3 Automatically tensioning and welding\* Fig. 77

By a brief pulling (touching) of the tensioning button once, the sealing process (tensioning and welding) will be activated. Once the set tension force has been reached, the straps are automatically welded and the upper strap is cut off.

\* This operating mode AUTO = Fully automatic strapping is factory blocked! Activation only through your ErgoPack service partner possible.



Fig. 76

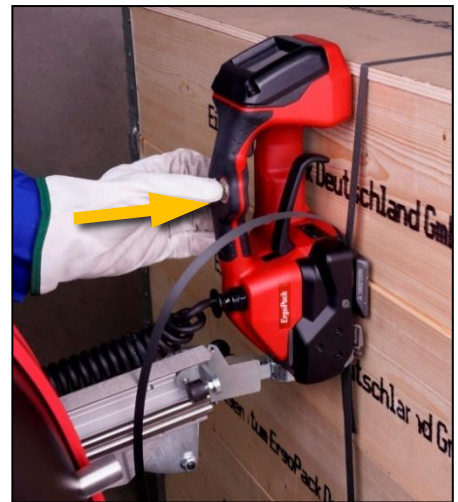

Fig. 77



### **Warning!**

#### **Strap tensioning or strapping, danger of jamming and crushing**

Do not place hands or other body parts between the strap and the packaged goods during the strapping process. Ensure that there are no other persons in the hazard zone.

#### **For an emergency stop in the case of danger (trapped person):**

To release the strap tension (before welding), actuate the rocker lever, the tensioning or welding button. After welding, cut the strap using a tool (strap cutter).

The tensioning process is finished, once the indicator bar is filled in fully.

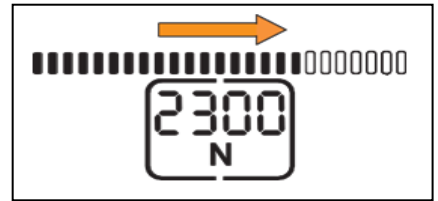

Fig. 78

The welding process is finished, once the indicator bar (1) is filled fully.

The cool down starts (2). After cool down there is a beep and the display lights up green.

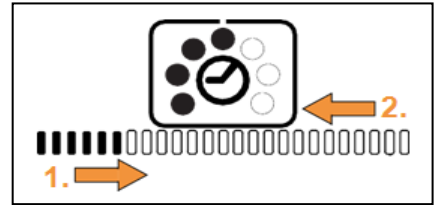

Fig. 79

### 6. Step

As soon as the countdown is finished and the signal has sounded you have to pull the rocker lever towards the handle.



#### **Attention!**

If after pressing the welding button, the welding process does not start, but the sealing head beeps, the tension button was not pressed first.

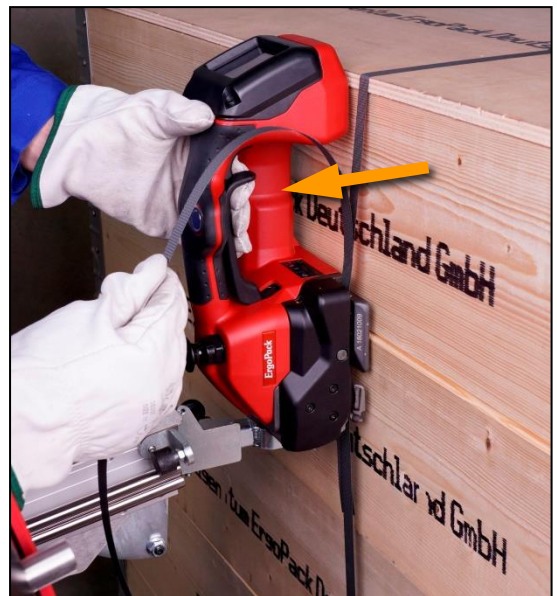

Fig. 80

### 7. Step

Now slew the sealing head to the left while keeping the rocker lever pulled..



#### **Attention!**

It is recommended to clean the sealing head regularly (at least daily), if there is a lot of strap waste. Especially the tension wheel and the tooth plate have to be checked for damages and kept clean. Please refer to section 10.10.

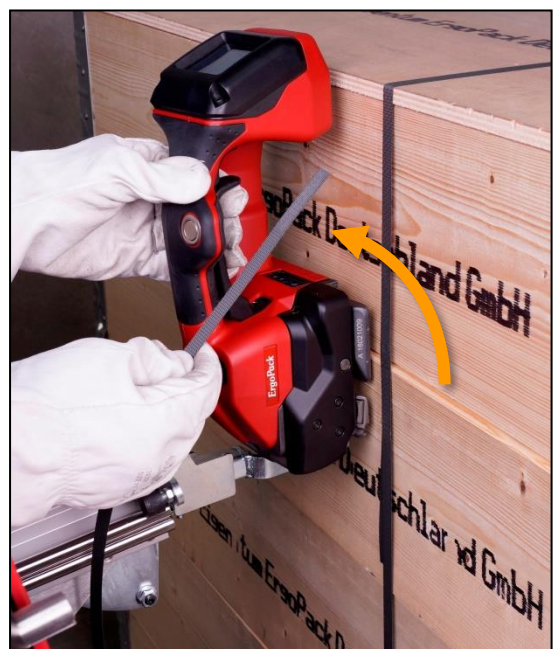

Fig. 81

## 8.3 Sealing control

Control the sealing regularly. The welding time must be checked in accordance with point 7.10 and changed if necessary when the straps are welded badly.

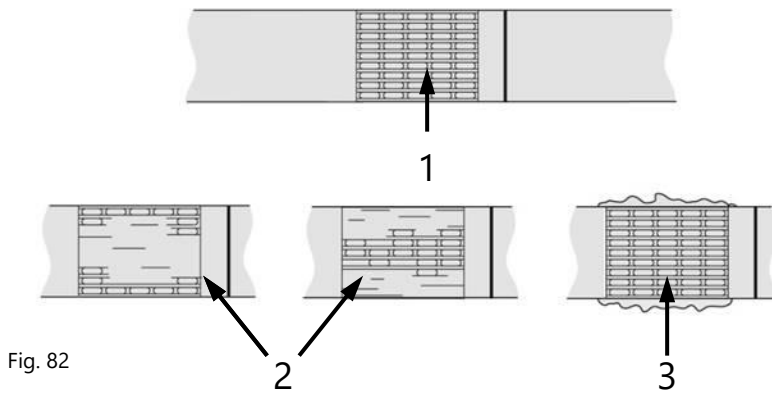

Fig. 82

**1 Good welding:** The whole sealed surface has been properly welded without any extra material being squeezed out to the side.

**2 Bad welding:** The surface has been unevenly welded, the selected welding time is too short.

**3 Bad welding:** Surplus material has been squeezed out to the side, the selected welding time is too long.



### **Warning!**

**Improper welded straps cannot secure the loads and can therefore cause injuries.**

Never transport or move goods with improper welded straps.



## 8.4 Tensioning and sealing pallets below 70 cm height with ErgoPack standard Tool-Lift



Fig. 83

### 1. Step

Pull out the black knob of the locking bolt. Afterwards, pull the sealing head forward out of the holder and place it on the package to be strapped.

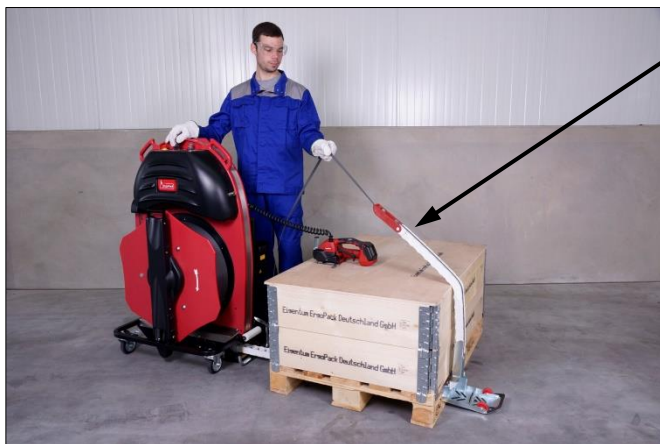

Fig. 84

### 2. Step

Strap the package exactly as described under point 8.1.



Fig. 85

### 3. Step

Overlap both straps so that the beginning of the strap lies underneath.

Pull the rocker lever to open the clamp of the sealing head.



Fig. 86

Now, with your right hand, feed the strap through the guiding of the sealing head, by pulling it towards yourself.



Fig. 87

#### 4. Step

The tensioning and the sealing of the strap is different according to the set mode (manual / semi-automatic or automatic mode, see point 7.8).



Fig. 88



Fig. 89

### 5. Step

As soon as the signal has sounded and the display lights up green, pull the rocker lever towards the handle and move the sealing head out to the left.



Fig. 90

### **If your strapping system is equipped with the optional Triplex Tool-Lift:**

Pull out the sealing head horizontally, slew the sealing head by 90° into horizontal position and put it on top of the pallet.

Tensioning and sealing proceed exactly as described in the previous steps.

## 9. Risks



### **Attention: Laser beam!**

Direct eye contact with the laser beam or reflecting radiation may result in permanent eye injuries.

Never look direct in the laser.

Laser category 2  
DIN EN 60825-1:2015-07

Power: 10 mW  
Wavelength: 635 nm

---



### **Warning:**

**Strap tensioning or strapping, danger of jamming and crushing.**

Do not place hands or other body parts between the strap and the packaged goods during the strapping process.

Ensure that there are no other persons in the hazardous zone.

**For an emergency stop in case of danger (trapped person):**

- To release tension (before welding), open the rocker lever.
  - After welding, cut the strap with a suitable tool (strap cutter)
- 



### **Warning:**

The following hazards can result in serious injury or death.

---

### **Explosion hazard in EX zones**

The strapping system must not be used in areas where an explosive atmosphere may occur.

---

### **Electric shock**

Strapping creates electrostatic charges. These can discharge via the user. The strapping system is therefore not suitable for operation by persons with implants such as pacemakers or defibrillators.



## **Warning!**

Following hazards can result in serious injuries:

---

### **Chain lance, risk of injury**

When the ChainLance moves upwards on the opposite side of the pallet, its own weight causes it to fall over the pallet towards the operator. **If you are not careful, the ChainLance can fall on the operator's head and cause injuries.** Always be alert and concentrated and catch the ChainLance if it falls over the pallet.

---

### **Incorrectly welded strapping cannot secure the load and can therefore lead to injuries.**

Never transport or move a packaged good with an incorrectly executed weld.

---

### **Breaking strap, risk of injury**

When being tensioned, the strap may break and rip. Do not stand in line with the strap and wear eye protection.

---

### **Strap ends snapping back, risk of injury**

When cutting the strap, hold the upper portion and stand aside. Do not stand in line with the strap and wear eye protection.

---

### **ChainLance, risk of tripping**

When parking the strapping system, the ChainLance must be fully inside it. The reversing sledge must not stick out.

---

### **Strap waste, risk of tripping**

Make sure any strap waste or pieces of strap, which possibly appeared, will be removed from the floor quickly.

---

### **Sealing head and ChainLance, risk of crushing**

Do not put your fingers into the area of the tension wheel of the sealing head and into the ChainLance.

---

### **Reversing sledge, risk of crushing**

Especially around the entire surroundings of the reversing sledge, there is a risk of squeezing.



### **Warning!**

Following hazards can result in serious injuries:

---

#### **Hazardous area, risk of crushing and risk of injury**

Make sure before each strapping cycle, that there is no person in the hazardous area (especially of the ChainLance) and nobody can enter that area. This is due, especially for the limited or bad visible area on the opposite site of the pallet (operators view). During strapping, there must not be any hands or other body parts between strap and goods.

---

#### **Power source, risk of injury**

Before maintenance or repair works:

Switch off the strapping system by pressing the „OFF“ switch, remove the key from the main switch and unplug the main power cable from the battery.

---



### **Caution!**

Following hazards can result in minor or moderate injuries:

---

#### **Strap coil, risk of injury**

While changing the strap coil, 2 persons need to transport and lift it, if the weight of the roll is 20 kg or heavier.

---

#### **Tilting danger**

Strapping pallets should, whenever possible, take place in areas with an even surface. When using the strapping system on inclined surfaces, after positioning and before strapping, the brakes of the castor wheels on the strap side have to be locked.



**Attention!**

Avoid damages on the strapping system:

---

**Water damages**

For cleaning of the strapping system do not use water or steam.

---

**Visual inspection**

Before using the strapping system for the first time, a visual inspection for external damage has to be done.

---

**Use only original ErgoPack spare parts!**

Warranty and liability become invalid if other than ErgoPack spare parts are used.

# 10. Service and repair

Your ErgoPack is made out of galvanized steel, powder coated steel, stainless steel and highly wear resistant plastic and is basically maintenance free.

Clean the outside of the ErgoPack with a damp cloth if it is extremely dirty.



## **Warning!**

During all maintenance and service/repair works, the strapping system has to be switched off by pressing the „OFF“ switch, the key has to be removed from the main switch and the main power cable must be unplugged from the battery pack.

## 10.1 Cleaning the ChainLance

Clean the ChainLance with acetone or petroleum if it has become dirty with oil. Always wear appropriate protective equipment.



## **Attention!**

Do not place the ChainLance into cleaner.  
Never use lubricants like grease or oil!



# 10.2 Replacing the ChainLance

## 1. Step

Cut off the strap in front of the white roll and fix it with an adhesive tape to the coil. Pull out the rest of the strap remained in the strapping system through the head piece of the ChainLance and dispose it.



Fig. 91

## 2. Step

(There are 2 options)

### Option 1

Set the pallet width at the display of the strapping system to 1m and drive out the ChainLance until the joint of the reversing sledge folds up and locks into this position.



Fig. 92

Afterwards, switch off the strapping system by pressing the OFF button and disconnect the power cable from the battery pack. For this purpose, the cover of the battery compartment has to be opened (by pulling at the wheel covers). (Fig. 93)



Fig. 93

### **Option 2**

Switch off the strapping system by pressing the OFF button and disconnect the power cable from the battery pack. For this purpose, the cover of the battery compartment has to be opened (by pulling at the wheel covers). (Fig. 93)



Fig. 94

94a

A second person presses downwards the „rocker“ of the locking unit (94a), which is connected with the magnet lock through the folding spring bolt. At the same time the other person pulls the reversing sledge out of the strapping system (Fig. 96).



Fig. 95

Now, pull out the reversing sledge by about 1 m and fold up the joint. (Fig. 96)



Fig. 96

### 3. Step

Pull the ChainLance out of the strapping system as shown and roll it up.



Fig. 97

#### 4. Step

Push the new ChainLance in again in reversed order of the removal.



Fig. 98

By pushing the end piece of the ChainLance into the system, the end pieces preloaded by a spring (Fig.99), has to be aligned straight (Fig. 100). Press the chain links down with your finger and push them into the strapping system ...



Fig. 99



Fig. 100

... so that the end of the ChainLance can be inserted into the groove of the ChainLance (Fig. 101) in the central part of the strapping system (Fig. 103).



Fig. 101

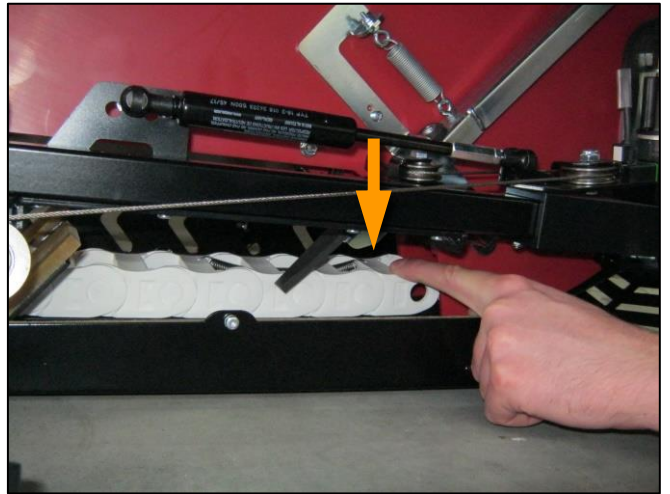

Fig. 102

Also for that, the preloaded chain links have to be pressed down with your finger (Fig. 102).

Groove of the ChainLance



Fig. 103

### 5. Step

Put the strapping system into operation in accordance with section 7.

## 10.3 Replacing the reversing sledge

### 1. Step

Cut off the strap in front of the white roll and fix it with an adhesive strip to the coil. Pull out the rest of the strap remained in the strapping system through the head piece of the ChainLance and dispose it.



Fig. 104

### 2. Step

Set the pallet width at the display of the strapping system to 1m and drive out the ChainLance...



Fig. 105

...until approx. 60 cm of the chain stands in an upward position. Then, switch off the strapping system by pressing the OFF button and disconnect the power cable from the battery pack.



Fig. 106

### 3. Step

Push a screwdriver (blade width 5,5 mm) between the wings of two chain links ...



Fig. 107

... and slew the chain to the side by turning the screwdriver carefully ...



Fig. 108

... until the two chain links fully separate.

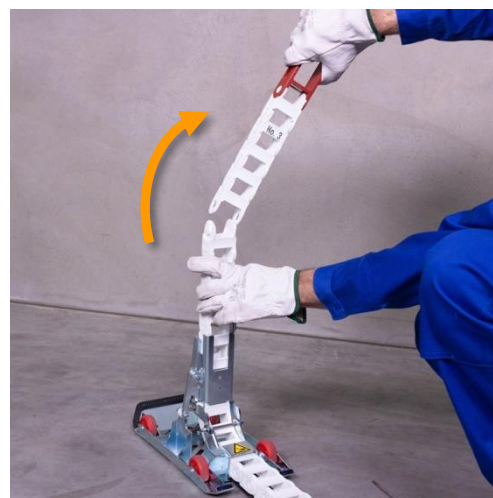

Fig. 109

#### 4. Step

Push the ChainLance manually back into the strapping system until the ChainLance has completely moved out of the reversing sledge.



Fig. 110

#### 5. Step

Place the reversing sledge on its top as illustrated and use a screwdriver to unscrew both screws of the length adjusting belt.

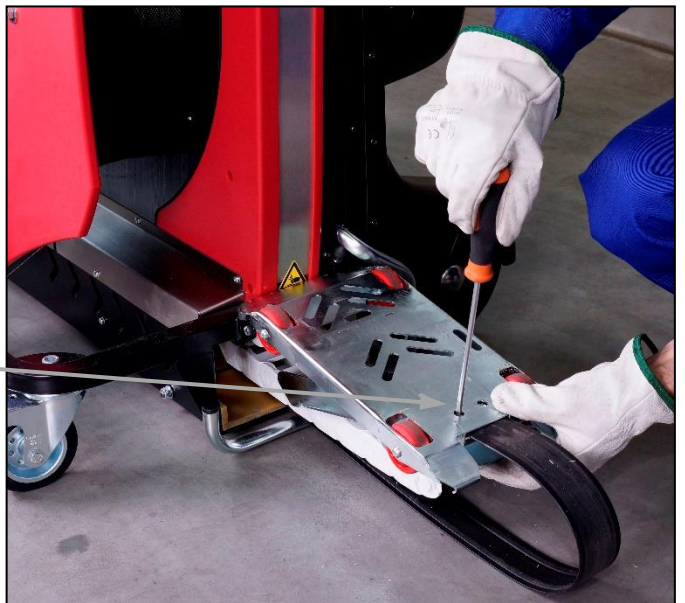

Fig. 111

#### 6. Step

The fitting of the reversing sledge is done in the reversed order of the dismantling.



#### **Attention!**

Both screws of the length adjusting belt must be protected with medium-tight screw retaining varnish!



## 10.4 Replacing individual chain links

In case of broken individual chain links, the ChainLance can be opened as described under point 10.2 to replace those defective chain links.

It is temporarily also possible to remove a defective chain link without the need to insert a new chain link.



### **Attention!**

After removing the chain link, the strapping system has to be restarted. After each restart, the control unit automatically adjusts to the correct zero position in accordance with point 8.4.



### **Note!**

As the new shorter chain length is unknown to the control unit, it may happen that when driving out the chain completely, the end of the chain will not be recognized correctly any longer and the ChainLance will be pushed out over the driving gearwheel.

This can cause a malfunction. Therefore, missing chain links should be replaced as soon as possible.

# 10.5 Replacing the length adjusting belt

## 1. Step (dismantling)

Perform steps 1 to 5 listed in point 10.3 and continue with step 2.

## 2. Step

Open the cover „battery compartment“ as described under point 7.2 „charging the battery pack“.

Now, unlock the ball lock pin by pressing the release button and pull it out of the storage plate.

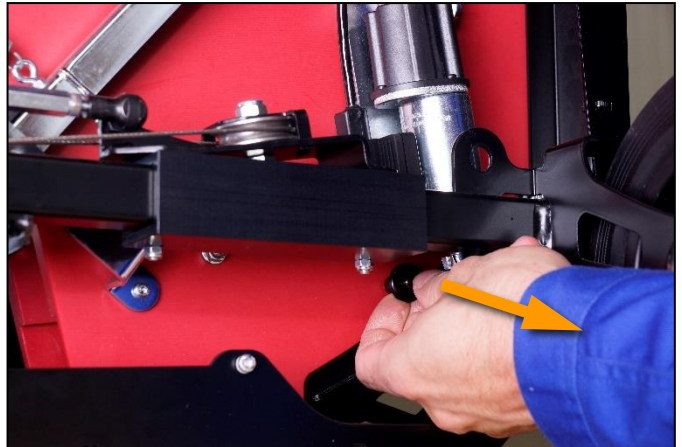

Fig. 112

## 3. Step

A second person presses downwards the „rocker“ of the locking unit which is connected with the magnet lock through the folding spring bolt. At the same time the other person pulls the length adjusting belt out of the strapping system.



Fig. 113

#### 4. Step (installation)

Push the ChainLance all the way back into the strapping system so that you can see the groove of the length adjusting belt.

#### 5. Step

Push the new length adjusting belt into the small groove below the groove for the ChainLance.

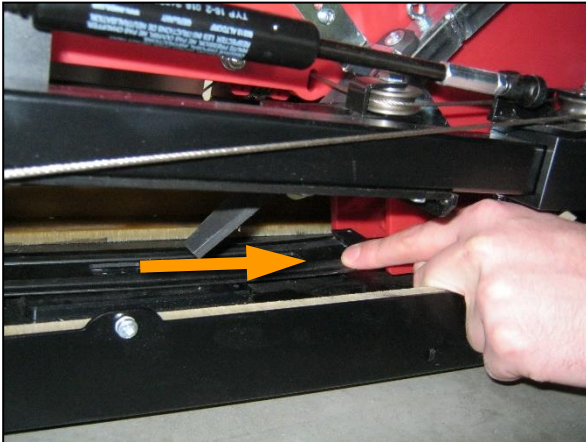

Fig. 114

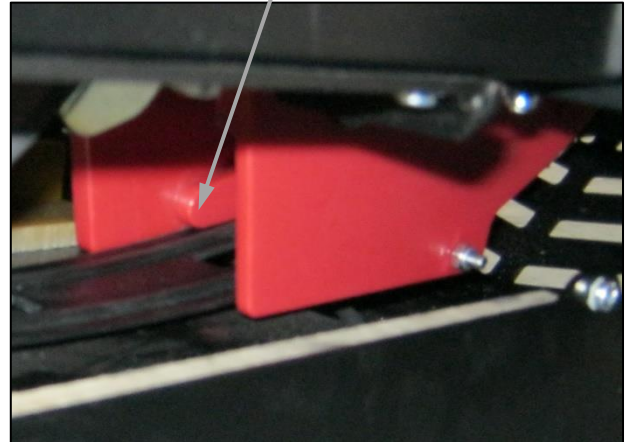

Fig. 115



#### **Attention!**

Make sure that the length adjusting belt is inserted into the lower groove and that it does not slide into the upper groove of the ChainLance.

#### 6. Step

The further installation is done in the reversed order of the dismantling.

## 10.6 Changing the sealing head



### **Warning!**

Improper handling of the electronic components can lead to defect or malfunction of the strapping system.

1. To prevent voltage flashover to electronic components during maintenance work, the person carrying out the maintenance must discharge himself (e.g. by touching a water pipe).
2. Observe the assembly and disassembly sequence in order to be able to safely discharge electrostatic charges.

### 1. Step

Drive out the Tool-Lift forwards so that the cover „display“ can be disassembled.



Fig. 116

### 2. Step

Remove the cover „display“ by pulling on the provided handle holes diagonally downwards. (The cover is fixed by magnets).



Fig. 117

### 3. Step

Unlock the red locking ring on the plug of the cable of the sealing head by turning it counter clockwise. Now, remove the plug.

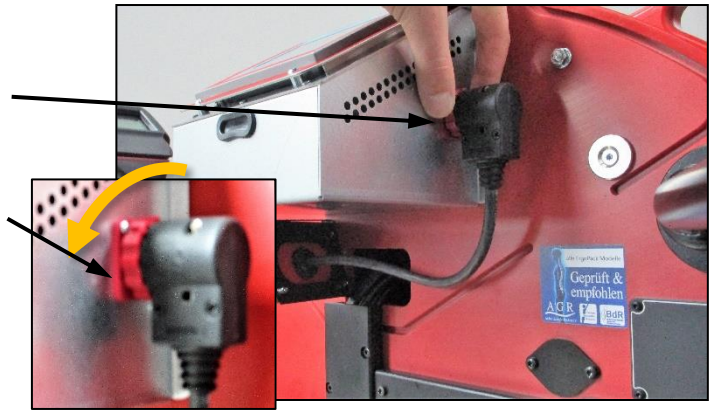

Fig. 118

### 4. Step

Remove the 4 screws of the red metal cover at the holder of the spiral cable.



Fig. 119

### 5. Step

Pull the cable with plug through the opening in the holder of the spiral cable.



Fig. 120

## 6. Step

Pull out the locking bolt for unlocking the sealing head and remove the sealing head.



Fig. 121

## If your strapping system is equipped with the optional Triplex Tool-Lift:

Remove both screws M5 (4mm Allen wrench). These screws are secured with special wedge-lock washers (the wedge-lock washers can be reused).

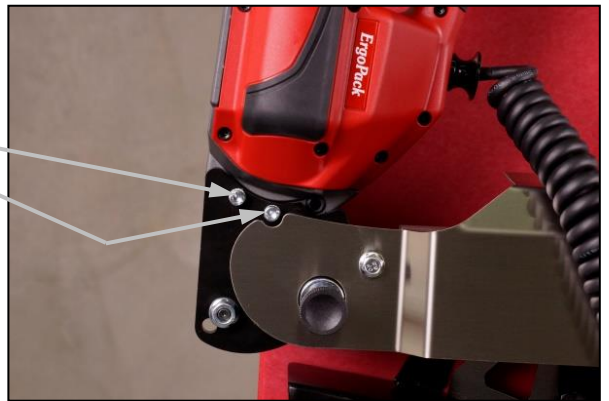

Fig. 122

## 7. Step

The mounting of the sealing head is to be done in reversed order of the dismantling. When mounting the cover „display“, take care to engage it first at the display and then all along the groove of the storage plate.



### **Attention!**

When mounting the sealing head again make sure that the rough tooth system of the two wedge-lock washers are facing each other (Fig. 123).

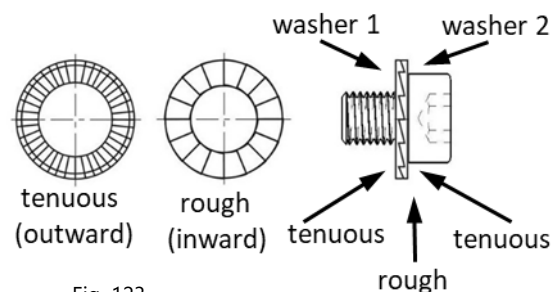

Fig. 123

# 10.7 Changing the control box joystick unit



## **Warning!**

Improper handling of the electronic components can lead to defect or malfunction of the strapping system.

1. To prevent voltage flashover to electronic components during maintenance work, the person carrying out the maintenance must discharge himself (e.g. by touching a water pipe).
2. Observe the assembly and disassembly sequence in order to be able to safely discharge electrostatic charges.

### 1. Step

Cut off the strap in front of the white roll and fix it with an adhesive strip to the coil. Pull out the rest of the strap remaining in the strapping system through the head piece of the ChainLance and dispose it.



Fig. 124

### 2. Step

Fold down the pivot arm.



Fig. 125

### 3. Step

Remove the cover „joystick“ by pulling on the handle holes, provided at the bottom side (the cover is fixed by magnets).



Fig. 126

### 4. Step

Fold the pivot arm upwards again.



Fig. 127

### 5. Step

At first, remove the plug of the power cable and afterwards all other plugs.



#### **Attention!**

The plugs are secured with a screw socket which has to be unlocked by turning it counter clockwise. Remove the plugs afterwards only.

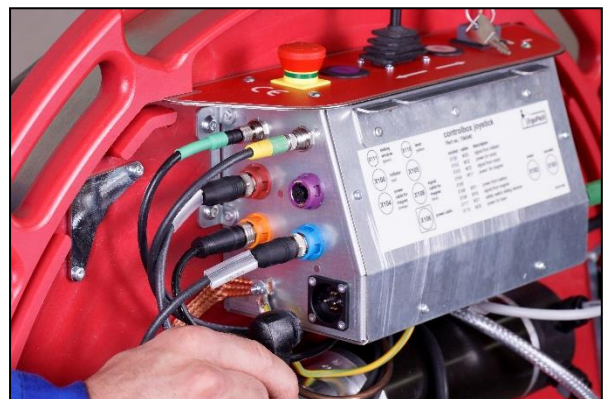

Fig. 128



## 6. Step

Remove the 4 screws on the side of the control unit.

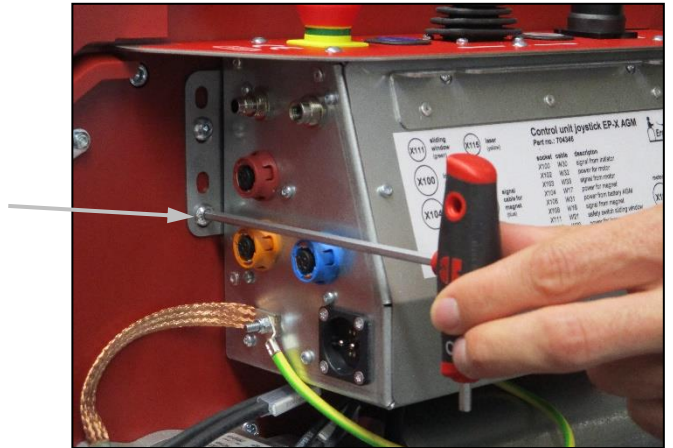

Fig. 129

## 7. Step

Now carefully loosen the plug connections on the back of the control unit.



### **Attention!**

Disconnect the earth cable (green-yellow) last.



### **Attention!**

For disconnecting the plug of the black/red cable, you have to pull the flap of the plug.

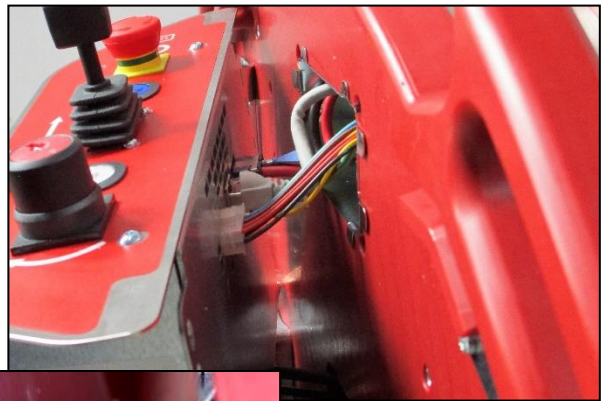

Fig. 130



## 8. Step

Remove the nut on the ground bolt/threaded stud and then pull off the ground cable and ground strap.

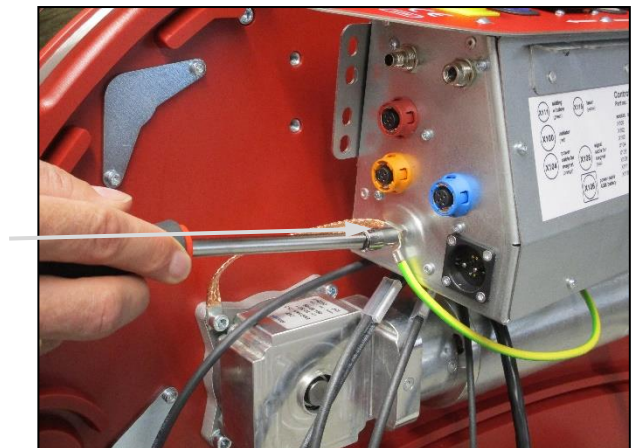

Fig. 131

## 9. Step

The installation of the control unit is done in the reversed order of the disassembling. While connecting the cables always take note of the information on the label (132a) located on the front side of the control unit.

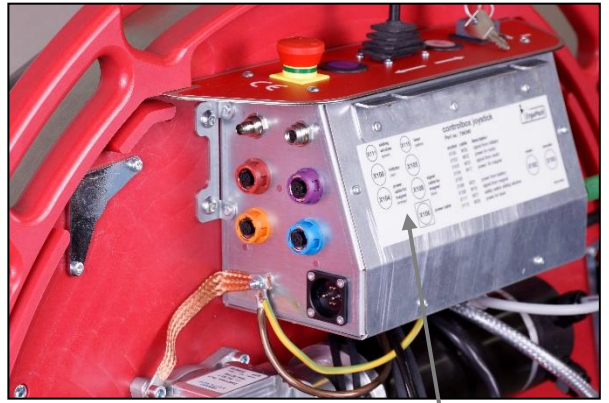

Fig. 132

132a



### ***Attention!***

The plug-in connection is positioned relative to one another through a plastic nose and groove. When having the correct position, connect the plug and secure it by the screw socket. This screw socket has to be closed by turning it clockwise. Only then, the function of the plug-in connection is ensured.

# 10.8 Changing the control box display unit



## **Warning!**

Improper handling of the electronic components can lead to defect or malfunction of the strapping system.

1. To prevent voltage flashover to electronic components during maintenance work, the person carrying out the maintenance must discharge himself (e.g. by touching a water pipe).
2. Observe the assembly and disassembly sequence in order to be able to safely discharge electrostatic charges.

### 1. Step

At first, remove the control box joystick unit as described in section 10.7.

### 2. Step

Drive out the Tool-Lift forwards so that the cover „display“ can be disassembled.



Fig. 133

### 3. Step

Remove the cover „display“ by pulling on the provided handle holes diagonally downwards. (The cover is fixed by magnets).



Fig. 134

#### 4. Step

Unlock the red locking ring on the plug of the cable of the sealing head by turning it counter clockwise. Now, remove the plug.

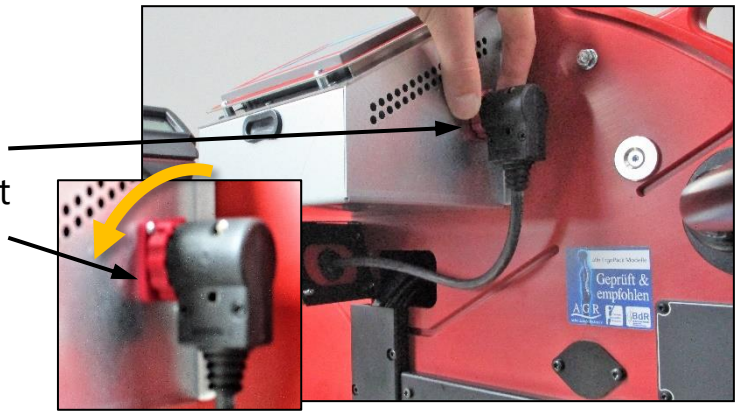

Fig. 135

#### 5. Step

Remove the 4 screws on the side of the control unit and...



Fig. 136

... remove the control box and thereby pull the cable carefully through the cable duct.

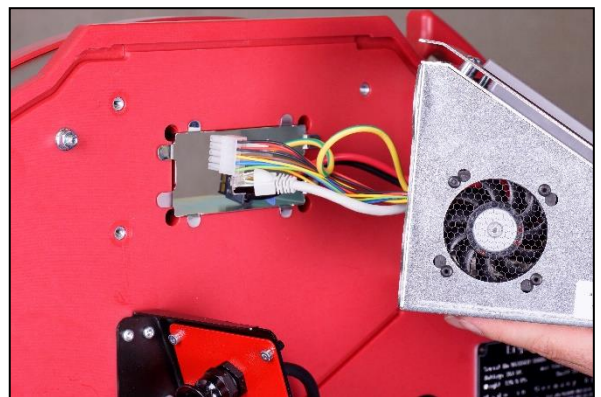

Fig. 137

#### 6. Step

The installation of the control unit is done in the reversed order of the disassembling.

## 10.9 Changing the motor



### **Warning!**

Improper handling of the electronic components can lead to defect or malfunction of the strapping system.

1. To prevent voltage flashover to electronic components during maintenance work, the person carrying out the maintenance must discharge himself (e.g. by touching a water pipe).
2. Observe the assembly and disassembly sequence in order to be able to safely discharge electrostatic charges.

### 1. Step

Cut off the strap in front of the white roll and fix it with an adhesive strip to the coil. Pull out the rest of the strap remaining in the strapping system through the head piece of the ChainLance and dispose it.



Fig. 138

## 2. Step

Fold down the pivot arm.



Fig. 139

## 3. Step

Remove the cover „joystick“ by pulling on the handle holes, provided at the bottom side (the cover is fixed by magnets).



Fig. 140

## 4. Step

Fold the pivot arm upwards again.



Fig. 141

## 5. Step

Unscrew the two plugs guided to the motor from the right side of the control box „joystick“ unit.



### **Attention!**

The plugs are secured with a screw socket which has to be unlocked by turning it counter clockwise. Remove the plugs only afterwards.

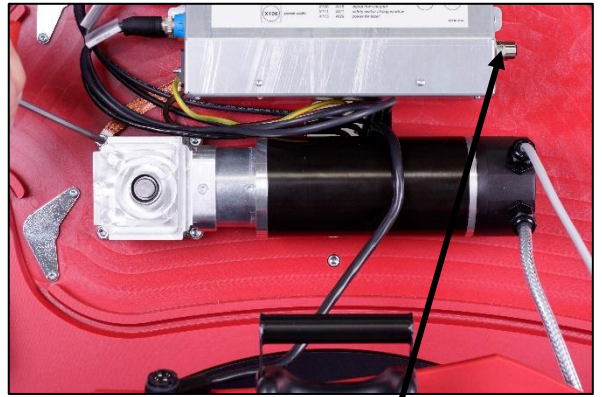

Fig. 142



Fig. 143

## 6. Step

First remove the 3 screws (144a) on the motor support plate , then remove the screw with the earth strap (144b) and ...

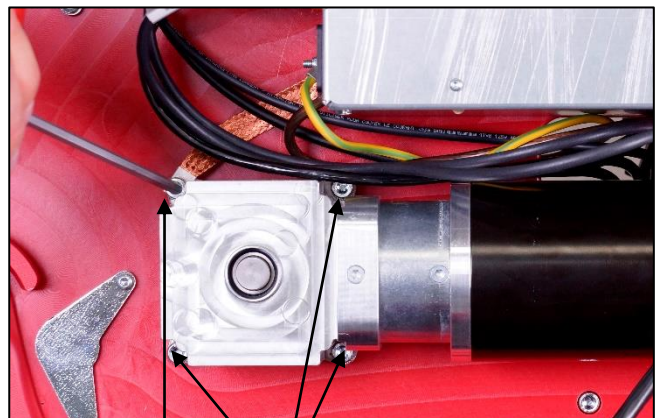

Fig. 144

144b 144a

... remove now the motor carefully.  
Take care not to lose the feather key (145a).

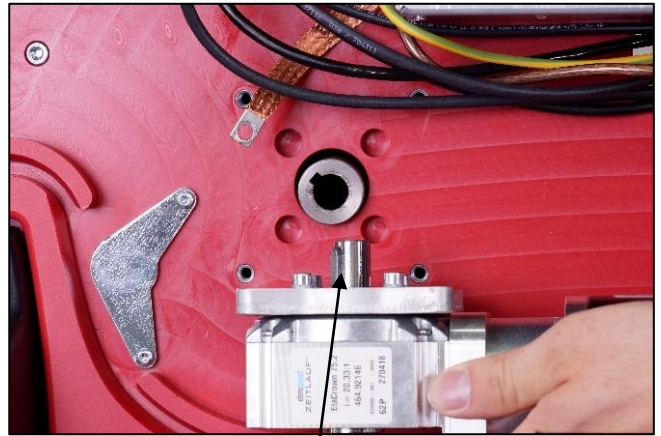

Fig. 145

145a

## 7. Step

The installation of the motor is done in the reversed order of the disassembling.



### **Attention!**

The plug-in connection is positioned relative to one another through a plastic nose and groove. When having the correct position, connect the plug and secure it by the screw socket. This screw socket has to be closed by turning it clockwise. Only then, the function of the plug-in connection is ensured.

The feather key at the motor output has to be positioned exactly to the groove in the shaft.



# 10.10 Cleaning/replacing the tension wheel at the sealing head

## Cleaning the tension wheel without disassembling

- There is an access hole (146a) in the protection cover below the motor. The tension wheel and the tooth plate can be cleaned with compressed air through this access hole.
- When heavily soiled, the tension wheel has to be disassembled.



Fig. 146

146a



### **Warning !**

Wear eye protection when cleaning with compressed air!

## Cleaning the tension wheel with disassembling / replacing the tension wheel

Release 4 cylinder screws (Torx) (4), remove strap guide rear (5) and side cover (3).

- Remove tension wheel (1) carefully.
- Remove ball bearing (2) from tension wheel.
- Clean the tension wheel with compressed air.
- If the tension wheel teeth are covered with heavy dirt they must be cleaned carefully with the wire brush (6) supplied.
- Check tension wheel for worn teeth. If a few teeth are broken, replace tension wheel (observe direction, see arrow).

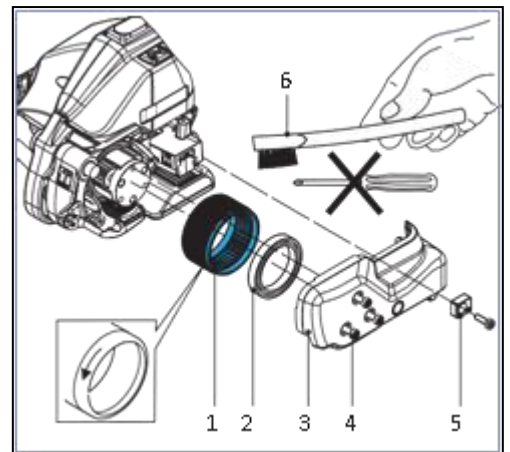

Fig. 147

- **Installation** is done in the reversed order of the disassembling.
- Grease interior gear teeth of the tension wheel lightly with Klüber grease GBU Y 131 (Microlube).



### **Attention!**

The tension wheel is extremely sensitive when it comes into contact with hard, especially metallic objects. A hard object, such as a screwdriver or similar, must not be used under any circumstances whatsoever for cleaning. The tension wheel must not be cleaned in an installed state when it is rotating. Risk of breakage teeth.

## 10.11 Cleaning/replacing the tooth plate at the sealing head



### **Warning !**

Wear eye protection when cleaning with compressed air!

- Remove pan head screw (1).
- Lift the rocker lever towards the handle and remove tooth plate (2).
- Clean tooth plate with compressed air.
- If the tooth plate teeth are covered with

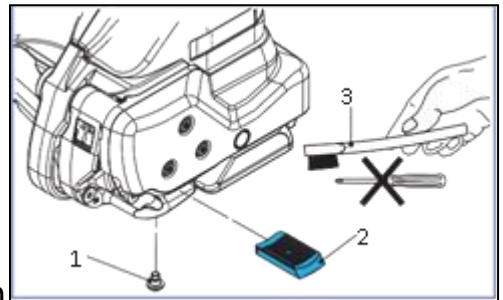

Fig. 148

- heavy dirt, they must be cleaned carefully with the wire brush supplied.
- Check tooth plate for worn teeth, if necessary, replace tooth plate.
- **Installation** is done in the reversed order of the disassembling.
- Secure pan head screw (1) with screw locking varnish "medium-tight".



### **Attention!**

The tooth plate (2) must be placed so that it can move freely in the rocker!

## 10.12 Replacing the cutter at the sealing head

- Release 4 cylinder screws Torx (3), remove strap guide rear (4) and side cover (2).
- Release cylinder screw Torx (5), take care that you do not loose the compression spring (7), remove knife (1) with flanged bushing (6) and replace knife.
- **Installation** is done in the reversed order of the disassembling.
- Before installing the knife (1), check that the compression spring (7) on top of the knife is still mounted.
- Secure the pan head screw (5) with screw locking varnish "medium-tight".

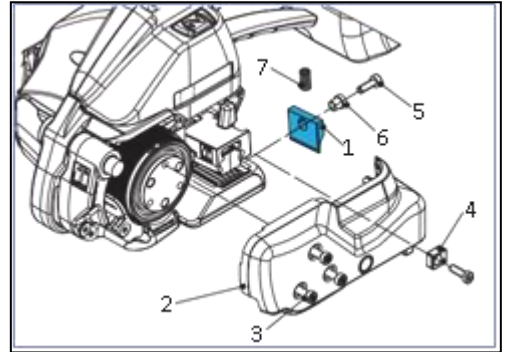

Fig. 149

# 11. Software Updates



## **Attention!**

Updates on the control units „Joystick“ and „Display“ only through trained and properly instructed staff. The necessary access code will be provided by your ErgoPack service partner.

### 1. Step

Remove the cover „joystick“ as described in section 10.7 step 1 to 4 and take off the cover „display“ in accordance with the instructions in point 10.8, step 1 to 3.

### 2. Step

Remove the rubber plugs from the USB-ports (150a/151a).



Fig. 150

150a



Fig. 151

151a

### 3. Step

Press the „F3” button (1) on the display and click „next” (2) until page 6 (3) of the menu appears. Unlock the lock (4) with the corresponding access code.

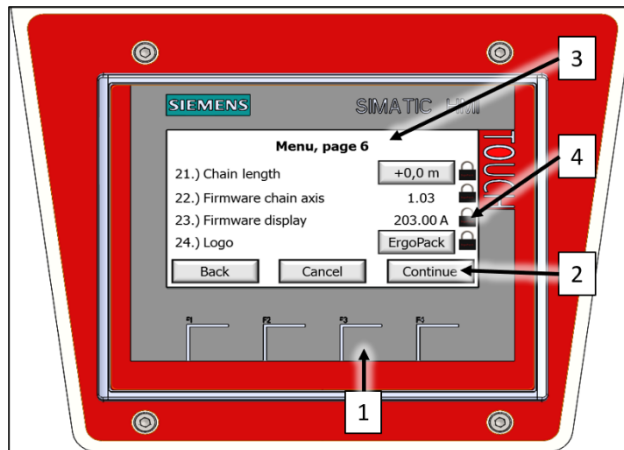

Fig. 152

### 4. Step

#### Firmware chain axis:

After unlocking, insert the USB stick with the current firmware into the USB port of the control unit „joystick” and start the update by confirming with „OK”.

As soon as the update was finished, the new version will be shown on the display!

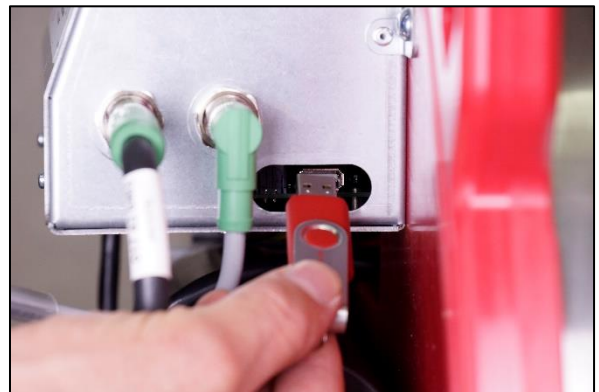

Fig. 153

### 5. Step

#### Firmware display:

After unlocking, insert the USB stick with the current firmware into the USB port of the control unit „display” and start the update by confirming with „OK”. Proceed further as described on page 94.



Fig. 154

## 6. Step

### Procedure of the update "display":

After confirmation, the start center appears.

Select now „settings“.

Click on the file „Service & Commissioning“.

Select „Restore“

Search your USB-stick by clicking on „Search“. After your USB-stick was found, scroll down and click on „>“ to go to the next step.

Start searching the backup file by clicking on „Search“. After the backup file was found, change to the next step by clicking „>“ at the bottom right.

By confirming with „Accept“, the upload process starts automatically and the installation begins. As soon as the message „EMERGENCY STOP pressed“ appears, remove the USB-stick. After unlocking the „EMERGENCY STOP“, press „RESET“. Now you are in the main menu.

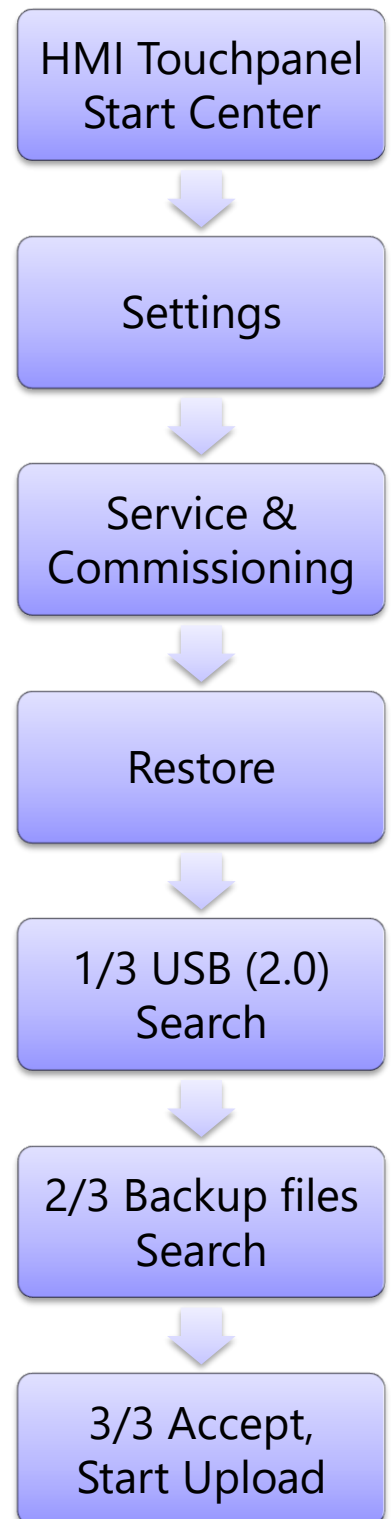

Fig. 155

## 12. Spare parts list

Spare parts lists with explosion drawings as well as the wiring plan and details about the updates of the control units can be found on our website **[www.ergopack.de](http://www.ergopack.de)** under "Downloads" as a PDF file.

**Please make a note of the type and serial number of your strapping system for the selection of your proper spare parts list.**

Please always state the number of the article when ordering spare parts (not the position number of the part on the explosions drawing).

# 13. Personal protective equipment



## **Inform yourself!**

Before usage of the strapping system, the operating instructions have to be read carefully and understood.

Service and maintenance on the strapping system have only to be done by trained staff.

---



## **Wear a safety helmet!**

When strapping pallets higher than 1,20 m, a safety helmet has to be worn.

The duty wearing a helmet can be avoided, if the user was taught about the risk of injury by the plastic chain falling and that particular caution is required. This instructions have to be recorded in writing.

---



## **Protect yourself!**

Wear eye and hand protection (cut proof gloves) and also safety shoes.



# 14. General safety warnings for power tools



## **Warning !**

Read all safety warnings and instructions. Failure to follow the warnings and instructions may result in electric shock, fire and/or serious injury.

### **Save all warnings and instructions for future reference.**

The term „power tool“ in the warnings refers to your mains-operated (corded) power tool or battery-operated (cordless) power tool.

### **Work area safety**

- a) **Keep the work area clean and well lit.** Cluttered or dark areas invite accidents.
- b) **Do not operate power tools in explosive atmospheres, such as in the presence of flammable liquids, gases or dust.** Power tools create sparks which may ignite the dust or fumes.
- c) **Keep children and bystanders away while operating a power tool.** Distractions can cause you to lose control.

### **Electrical safety**

- a) **Power tool plugs must match the outlet. Never modify the plug in any way. Do not use any adapter plugs with earthed (grounded) power tools.** Unmodified plugs and matching outlets will reduce the risk of electric shock.
- b) **Avoid body contact with earthed or grounded surfaces such as pipes, radiators, ranges and refrigerators.** There is an increased risk of electric shock if your body is earthed or grounded.

- c) **Do not expose power tools to rain or wet conditions.** Water entering a power tool will increase the risk of electric shock.
- d) **Do not abuse the cord. Never use the cord for carrying, pulling or unplugging the power tool. Keep the cord away from heat, oil, sharp edges or moving parts.** Damaged or entangled cords increase the risk of electric shock.
- e) **When operating a power tool outdoors, use an extension cord suitable for outdoor use.** Use of a cord suitable for outdoor use reduces the risk of electric shock.
- f) **If operating a power tool in a damp location is unavoidable, use a residual current device (RCD) protected supply.** Use of an RCD reduces the risk of electric shock.

### Personal safety

- a) **Stay alert, watch what you are doing and use common sense when operating a power tool. Do not use a power tool while you are tired or under the influence of drugs, alcohol or medication.** A moment of inattention while operating power tools may result in serious personal injury.
- b) **Use personal protective equipment. Always wear eye protection.** Protective equipment such as dust masks, non-skid safety shoes, hard hat or hearing protection used for appropriate conditions will reduce the risk of personal injuries.
- c) **Prevent unintentional starting. Ensure the switch is in the off-position before connecting to the power source and/or battery pack, picking up or carrying the tool.** Carrying power tools with your finger on the switch or energising power tools that have the switch on, invites accidents.
- d) **Remove any adjusting key or wrench before turning the power tool on.** A wrench or a key left attached to a rotating part of the power tool may result in personal injury.

- e) **Do not overreach. Keep proper footing and balance at all times.** This enables better control of the power tool in unexpected situations.
- f) **Dress properly. Do not wear loose clothing or jewellery. Keep your hair, clothing and gloves away from moving parts.** Loose clothes, jewellery or long hair can be caught in moving parts.
- g) **If devices are provided for the connection of dust extraction and collection facilities, ensure these are connected and properly used.** Use of dust collection can reduce dust-related hazards.

### **Power tool use and care**

- a) **Do not force the power tool. Use the correct power tool for your application.** The correct power tool will do the job better and safer at the rate for which it was designed.
- b) **Do not use any power tool with a defective switch.** Any power tool that can not be controlled with the switch is dangerous and must be repaired.
- c) **Disconnect the plug from the power source and/or the battery pack from the power tool before making any adjustments, changing accessories, or storing power tools.** Such preventive safety measures reduce the risk of starting the power tool accidentally.
- d) **Store power tools out of the reach of children and do not allow persons unfamiliar with the power tool or these instructions to operate the power tool.** Power tools are dangerous in the hands of untrained operators.
- e) **Maintain power tools. Check for misalignment or binding of moving parts, breakage of parts and any other condition that may affect the power tool's operation. If damaged, have the power tool repaired before use.** Many accidents are caused by poorly maintained power tools.
- f) **Keep cutting tools sharp and clean.** Properly maintained cutting tools with sharp cutting edges are less likely to bind and are easier to control.

- g) Use the power tool, accessories and tool bits etc. in accordance with these instructions, taking into account the working conditions and the work to be performed.** Use of the power tool for operations different from those intended could result in a hazardous situation.

### **Battery tool use and care**

- a) Recharge the battery packs only with the charger specified by the manufacturer.** A charger that is suitable for one type of battery pack may create a risk of fire when used with another battery pack.
- b) Use power tools only with specifically designated battery packs.** Use of any other battery packs may create risk of injury and fire.
- c) When the battery pack is not in use, keep it away from metal objects, like paper clips, coins, keys, nails, screws or other small metal objects, that can make a connection from one terminal to another.** Shorting the battery terminals together may cause burns or fire.
- d) Under abusive conditions, liquid may be ejected from the battery; avoid contact. If contact accidentally occurs, flush with water. If liquid contacts eyes, additionally seek medical help.** Liquid ejected from the battery may cause irritation or burns.

### **Service**

- a) Have your power tool serviced by a qualified repair person using only identical replacement parts.** This will ensure that the safety of the power tool is maintained.







