



Original Operating Instructions

**For ErgoPack
700/700E/713E/726E/745E**

Declaration of conformity

EU declaration of conformity for the purposes of the EU machine directive 2006/42/EG

ErgoPack Deutschland GmbH
Hanns-Martin-Schleyer-Str. 21
89415 Lauingen

We hereby declare that the strapping systems "ErgoPack 700, 700E, 713E, 726E, 745E", to which this declaration refers complies with all the relevant and basic health and safety requirements because of their concept, type of construction and the model we have brought on to the market.

This declaration loses its validity if a change is made to the system without our permission.

Respective

EC directives:

EC Machine directive (2006/42/EG)
EC Guideline on electromagnetic compatibility
(2014/30/EU)

Applied standards

EN 12100: 2010
EN 415-8: 2008
EN 61000-6-2:2005
EN 55011: 2018-05
EN 60 204-1: 2006

Since strapping system: 0319XXXX/9000

Since year of manufacture: 2019

Lauingen, 03th May, 2018



Andreas Kimmerle
CEO

Authorised representative for publishing technical documentation:

ErgoPack Deutschland GmbH
Hanns-Martin-Schleyer Str. 21
89415 Lauingen

Validity of the operating instructions

- **The operation in these instructions is explained by using the ErgoPack 726E as an example.**
- **As to ErgoPack 700, all the points in these instructions referring to the operation of the sealing head and also all points referring to the operation of the control box with the motor, charger and rechargeable batteries are not applicable. Also at all points in which the movement of the ChainLance is described by using the joystick, at the ErgoPack 700 you have to use the crank handle accordingly.**
- **All points in these instructions referring to the operation of the sealing head are not applicable as far as the “ErgoPack 700E” is concerned.**

These operating instructions are valid for the following models:

ErgoPack 700

Strapping system with manual drive via a hand crank, without sealing head

ErgoPack 700E

Strapping system with electrical drive, electronically controlled via a joystick, without a sealing head

ErgoPack 713E

Strapping system with electrical drive, electronically controlled via a joystick, with a sealing head for strap width of 9-13 mm and a maximum tension of 1200 N

ErgoPack 726E

Strapping system with electrical drive, electronically controlled via a joystick, with a sealing head for strap width of 12-16 mm and a maximum tension of 2500 N

ErgoPack 745E

Strapping system with electrical drive, electronically controlled via a joystick with sealing head for strap width of 15-19 mm and a maximum tension of 4500 N

Table of contents

	Page
1 Technical data	
1.1 Strapping system	6
1.2 Sealing head	7-8
1.3 Battery and charger	9
2 General	10-11
2.1 Notes on environmental protection	11
3 Safety regulations	12-15
3.1 Safety regulations for battery pack and charger	15
4 Description	16
4.1 Construction	16
4.2 Operating panel strapping system	17
4.3 Operating panel sealing head	17
4.4 Indications of the Dual-Charger	18
5 Commissioning	19
5.1 Battery charger	19
5.2 Charging the battery pack	19-21
6 Operation	22
6.1 Setting strap width at the sealing head	22
6.2 Switching on the control unit	23
6.3 Setting strap tension range at the sealing head	24
6.4 Setting strap tension at the sealing head	25
6.5 Setting mode of operation at the sealing head	26
6.6 Select favorite	27
6.7 Changing strap coil	28-41
6.8 Strapping	42-46
6.9 Tensioning and sealing pallets above 70 cm height	47-50
6.10 Sealing control	51
6.11 Setting welding time	52
6.12 Tensioning and sealing of pallets below 70 cm height	52-54
7 Service and repair	55
7.1 Cleaning the ChainLance	55
7.2 Replacing the ChainLance	56
7.3 Replacing individual chain links	57
7.4 Replacing the reversing sledge	58-59
7.5 Replacing the length adjusting belt	60-61

7.6	Changing the sealing head	62-63
7.7	Changing the control box with the motor	64-65
7.8	Cleaning/replacing the tension wheel at the sealing head	66
7.9	Cleaning/replacing the tooth plate at the sealing head	67
7.10	Replacing the cutter at the sealing head	68
8	Save moving and parking	69
9	General safety warnings for power tools	70-73

1. Technical Data

1.1 Strapping system

Weight:

ErgoPack 700	64,4 kg
ErgoPack 700E (incl. battery pack)	88,1 kg
ErgoPack 713E (incl. battery pack)	92,1 kg
ErgoPack 726E/745E (incl. battery pack)	92,9 kg

Dimensions (all types)

Length	630 mm
Width	770 mm
Height	1200 mm

Maximum chain speeds

Mode A, strapping

Moving out horizontally:	40 m/min
Moving out vertically:	60 m/min
Moving in vertically:	44 m/min
Moving in horizontally:	54 m/min

Mode B: setting up/threading strap

Moving out	20 m/min
Moving in:	16 m/min

Max. chain thrust:

310 N

Measured A-graded

noise emission level (EN ISO 11202)	L _{pa}	79 dB (A)
--	-----------------	-----------

1.2 Sealing head

Weight: 3,8 – 4,3 kg
(incl. spiral cable)

Dimensions length 335 mm
(incl. spiral cable) width 140 mm
height 180 mm

Tension
713E 150-1200 N
726E 400-2500 N
745E 400-4500 N

Tensioning speed
290 mm/s (713E)
220 mm/s (726E)
120 mm/s (745E)

Sealing friction welding

Measured A-graded noise emission level (EN ISO 11202)			(EN 60745-1/2:2009)	
713E	L _{pa}	79 dB (A)	L _{paeq}	77 dB (A)
726E	L _{pa}	78 dB (A)	L _{paeq}	82 dB (A)
745E	L _{pa}	79 dB (A)	L _{paeq}	81 dB (A)

Sound power level, on average
(EN 60745 -1/2:2009)

713E	L _{waeq}	88 dB (A)
726E	L _{waeq}	93 dB (A)
745E	L _{waeq}	92 dB (A)

Measuring inaccuracy K

713E	3,0 dB (A)
726E	3,0 dB (A)
745E	3,0 dB (A)

Hand arm vibrations (EN 60745-1/2:2009)	without using a Tool-Lift
713E	a 2,4 ms ⁻²
726E	a 2,4 ms ⁻²
745E	a 2,3 ms ⁻²

Measuring inaccuracy K

713E	1,5 ms ⁻²
726E	1,5 ms ⁻²
745E	1,5 ms ⁻²

Plastic strap

Strap materials	Polypropylene (PP) Polyester (PET)
-----------------	---------------------------------------

Strap width

713E, adjustable to	9-10 mm 12-13 mm
726E, adjustable to	12-13 mm 15-16 mm
745E, adjustable to	15-16 mm 18-19 mm

Strap thickness

713E	0,40 - 0,80 mm (PET) 0,50 - 0,80 mm (PP)
726E	0,50-1,00 mm (PET/PP)
745E	0,80-1,30 mm (PET/PP)

1.3 Battery and Charger

Charger	3 stage lead charger Prim.: 100-240 VAC 50/60Hz max. 1,2A Sec.: 2x 12V DC/2A Total max. power 60W
Battery pack	24V lead AGM battery
Weight:	12.3 kg
Charging time:	approx. 8 hours
Temperature range:	5 °C – 40 °C
Number of strappings:	150 to 400 per charge, depending on pallet size, tension, welding time and age of battery
Life span:	approx. 300-500 charges

2. General

These operating instructions will help you to understand the strapping system and how to use it according to regulations. The operating instructions contain important notes on how to use the strapping system safely, properly and economically.

Adhering to the notes helps you to avoid dangers, repairs and down times and also increases the reliability and life span of the strapping system.

The operating instructions must be available where the strapping system is used. It has to be read, understood and used by everybody who works with the strapping system.

These works include operation, maintenance and repair.

In addition to the operating instructions and the rules in the country and place of use for the prevention of accidents, the recognized special rules for working safely and according to proper and professional standards also have to be respected.

Meaning of warning symbols, usage conventions



Warning

Marks a hazard with moderate risk.
If not avoided, it can result in death or serious injury.



Caution

Marks a hazard with a minor risk.
If not avoided, it can result in a minor or moderate injury.



Attention

Marks a situation to be considered.
If not considered, it can lead to material damage or poor operating results.



Marks useful, additional information.

2.1 Notes an environmental protection

Physical or chemical materials dangerous to health have not been used for manufacturing the strapping system.

Concerning waste disposal, valid national rules and regulations have to be considered. Take care about disposing packaging, the product itself and parts accordingly.

Special dealers offer disposal according to proper environmental protection.

- Do not open the battery
- Do not throw the used battery into the domestic waste bin, into fire or into water.

3. Safety regulations



Inform yourself!

Before usage, the manual has to be read and understood.
Service and maintenance has to be done by trained staff only.



Wear a safety helmet!

Wear a safety helmet, when strapping pallets higher than 1.20m.
The duty wearing a helmet, can be avoided, if the user was taught about the risk of injury by the plastic chain falling.
This instruction has to be recorded in writing.



Protect yourself!

Wear eye and hand protection (cut proof gloves) and also safety shoes.



Attention: Laser beam!

Direct eye contact with the laser beam or reflecting radiation may result in permanent eye injuries. Never look direct in the laser.

Laser category 2
DIN EN 60825-1:2015-07

Power: 10 mW
Wavelength: 635 nm



Warning:

Strap tensioning or strapping, danger of jamming and crushing.

Do not place hands or other body parts between the strap and the packaged goods during the strapping process. Ensure that there are no other persons in the hazardous zone..

For an emergency stop in the case of danger (trapped person):

- To release tension (before welding), open the rocker lever.
- After welding, cut the strap with a suitable tool (strap cutter)



Warning:

Following hazards can result in serious injuries:

Breaking strap, risk of injury

When being tensioned, the strap may break and rip. Do not stand in line with the strap and wear eye protection.

Strap ends snapping back, risk of injury

When cutting strap, hold the upper portion and stand aside. Do not stand in line with the strap and wear eye protection.

ChainLance, risk of tripping

When parking the strapping system, the ChainLance must be fully inside the strapping system. The sledge must not stick out.

Strap waste, risk of tripping

Make sure any strap waste, which possibly appeared, will be removed from the floor quickly.

Sealing head and ChainLance, risk of crushing

Do not put your fingers into the area of the tension wheel of the sealing head and into the ChainLance.

Reversing sledge, risk of crushing

Especially around the entire surroundings of the reversing sledge, there is a risk of squeezing.

Hazardous area, risk of crushing and risk of injury

Make sure before each strapping cycle, there is no person in the hazardous area (especially of the ChainLance) and nobody can enter that area. This is due, especially for the limited or bad visible area, on the opposite site of the pallet (users view). During strapping, there must not be any hands or body parts between strap and goods.

Power source, risk of injury

Before maintenance or repair works: Switch main switch to “0” and unplug the cable from the battery.

EX Areas, risk of explosion

The system must not be used in areas with explosive atmospheres.

**Warning:**

Following hazards can cause serious injuries:

ChainLance, risk of injury

After the ChainLance moved up on the opposite side of the pallet, it falls towards the user with its own weight.

Used without paying attention, the ChainLance can fall on the head of the user and cause injuries. When using the system, watch out and be concentrated and catch the ChainLance, when it falls over.

Loose and falling goods

Check the weld. Never transport or move strapped goods with an improper welded strap.

**Caution:**

Following hazards can result in minor or moderate injuries:

Strap roll, risk of injury

If the strap roll is 20 kg or heavier, 2 persons need to lift it.

Tilting danger

Strapping pallets should, whenever possible, take place in areas with an even surface. When using the strapping system on inclined surfaces, after positioning and before strapping, the brakes of the castor wheels on the strap side of the strapping system have to be

**Attention:**

Avoid damages:

Water damages

For cleaning do not use water or steam.

Visual inspection

Before using the strapping system the first time, a visual inspection has to be done.

Only use original ErgoPack spare parts!

Warranty and liability become invalid if other parts are used.

Intended use

This strapping system is designed for strapping pallets/ loading carriers. The strapping system has been developed and constructed for safe operation when strapping.

The system is only to be used for strapping with plastic straps (polypropylene and polyester). Strapping with a steel strap is not possible with this strapping system.

The system is not designed to strap aliments which are not packaged.

The set up tension force must correspond to the packaged goods to be strapped. The construction of the strapping system does not consider any risk to damage goods, because of the strapping itself and/ or improper set tension force.

3.1 Safety regulations for battery pack and charger

- Check the plug and the cable before each use and have them replaced by a specialist if they are damaged
- Do not use any batteries from other manufacturers, use original spare parts only.
- Keep the connection plug to the battery pack away from non-related objects and dirt.
- Protect the charger from moisture; operate it in dry rooms only.
- Do not open the battery and protect it from shock, heat and fire. Danger of explosion!
- Store batteries in a dry frost-proof place. The ambient temperature must not exceed 50°C and must not fall below -5°C.
- Damaged batteries may not be reused.

4. Description

4.1 Construction



Fig. 1



Fig. 3

- Control unit with drive
- Cutter
- Strap brake



Fig. 2



Fig. 4

- Sealing head
- Sliding window with safety switch
- Tool-Lift
- Cover of battery pack

4.2 Operating panel strapping system

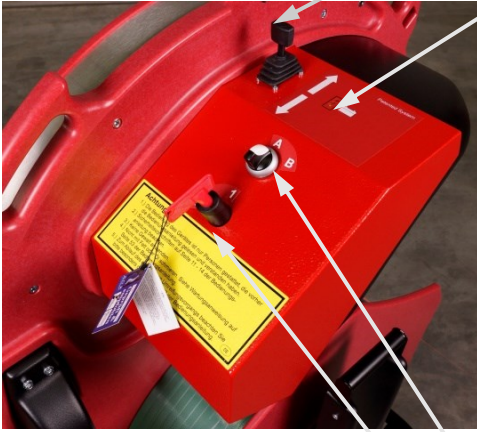

Fig. 5

Joystick to move "ChainLance" in and out with precision speed control.

LED display

Permanent light green = battery full

Permanent light

green + yellow = battery will soon be empty

permanent yellow light = battery empty, control unit switches off

(Control unit switches off when battery voltage $\leq 23,7V$)

Flashing green + yellow = teaching mode

Flashing light green or yellow = setup mode

Quickly flashing red = sliding window open

Rotary switch: A = strapping mode

B = setup mode

Main switch "power supply 1/0"

4.3 Operating panel sealing head

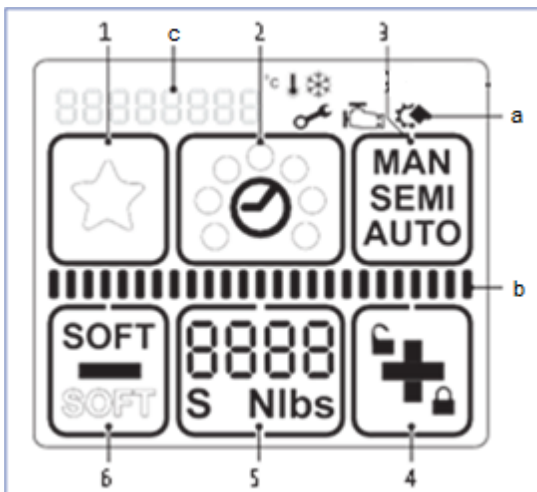

Fig. 6

1 "Favorite"

2 "Welding time"

3 "Operating mode"

4 "Plus & Keylock"

5 "Tensioning force"

6 "Minus & Soft tension"

a Display "Information symbols,"

b Status indicator bar "Tensioning/Welding"

c Display "Messages"



Display activated.



Welding process is finished, tool can be removed

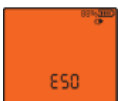

Application error: temporary system error, can be rectified by the operator



Tool fault: static system error, rectify error. If the error cannot be rectified -> Service department ErgoPack

4.4 Indications of the Dual-Charger

Inside the red battery housing there are two 12V batteries installed. The dual charger charges each of the two batteries separately.

The dual charger has one LED- indication for each of the two 12V batteries. (Output I and Output II), indicating the charging status of each battery.

LED permanent yellow = Charging battery. **Do not remove battery pack from the charger!**

LED permanent green = Battery fully charged, charger switches into preserving mode.

Note: The battery pack only is fully charged, **if both** LED indication lights are permanent green!

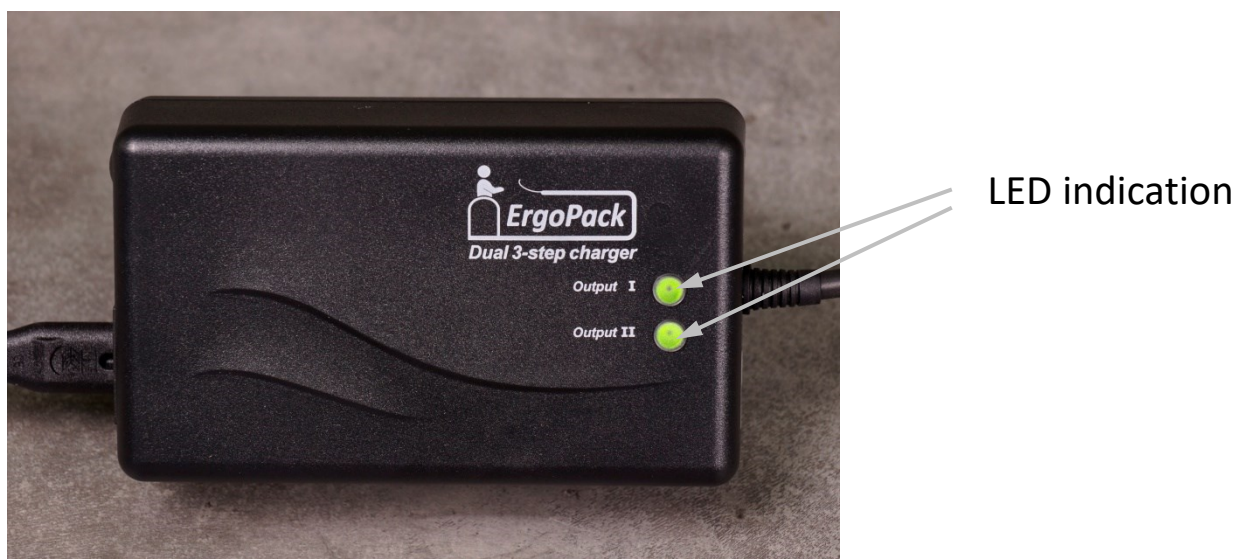

Fig. 7

5. Commissioning



Attention!

Before using the strapping system for the first time, a visual inspection for exterior damages has to be done.

5.1 Battery charger

The main voltage must comply with the details on the type plate.
The charger is only suitable for charging the delivered 24V lead battery.

5.2 Charging the battery pack

- 1.) Connect charger to the main voltage.
- 2.) Open cover of battery case (by pulling at the outer corners as shown below.)



Fig. 8

- 3.) Turn the red ring (12) of the plug (13) on the battery pack (7) counter clockwise.
- 4.) Disconnect the plug (13) from the battery pack and put it into the hole of the storage box above.

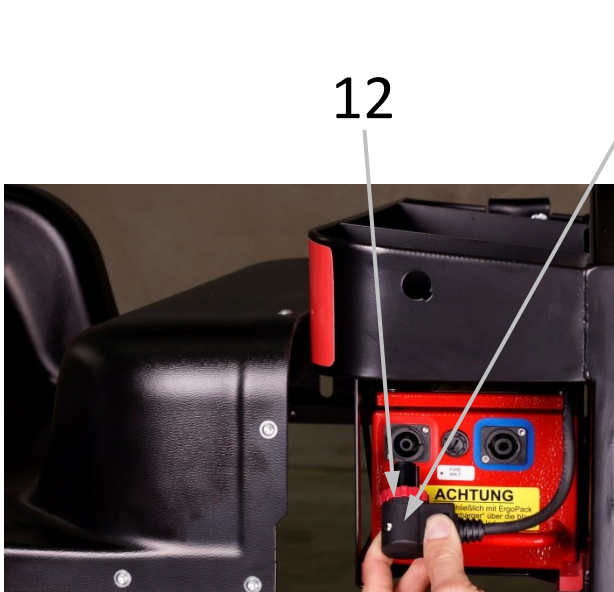

Fig. 9



Fig. 10a

7



Warning!

Charge the battery pack only with the ErgoPack Dual-3-step charger through the blue socket!

- 5.) Put the plug (14) of the charger into the blue charging socket of the battery pack (7) as shown in Fig 10b by slanting to the lower left corner. Thereafter turn the plug clockwise by 45° as shown in Fig. 10c until final snap in



Fig. 10b



Fig. 10c

14



Fig. 10d

- 6.) To remove the blue charging plug after charging is completed please proceed as follows:
- a) pull the silver locking bar (15) backwards
 - b) turn the plug by 45° counter clockwise
 - c) remove the plug



Attention!

The charging time is approximately 8 hours. The battery pack is fully charged not before **both** LED indication lights on the charger are shining green!

The maximum charging current flows if the temperature of the battery pack is between 5 - 40°C. Avoid battery temperatures below 0°C when charging.

You achieve the longest life span, if the battery pack is charged daily and is not being operated until the control unit switches off.

(only the yellow LED light is shining on the control box).

During charging, the battery pack always has to be in a horizontal position (cover upside, battery must not be in upright position).

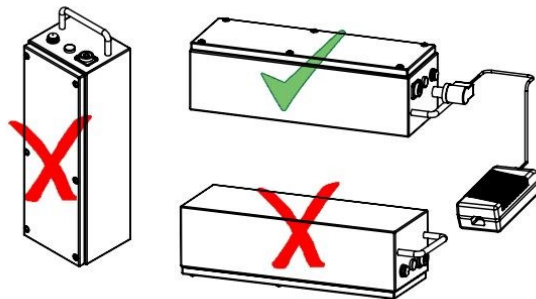

Fig. 11

6. Operation

6.1 Setting strap width at the sealing head

The sealing head can be used with different strap widths:

ErgoPack 713E:	9-10mm or 12-13mm
ErgoPack 726E:	12-13mm or 15-16mm
ErgoPack 745E:	15-16mm or 18-19mm

The setting of the strap width is explained using the example of model 726E. The setting of the strap width with the models 713E from 9-10 mm to 12-13 mm and 745E from 15-16 mm to 18-19 mm works accordingly.

a) Change strap width from 12–13 mm to 15–16 mm

- Switch the strapping system off
- Release three cylinder screws Torx (6). Lift the rocker lever towards the handle, release cylinder screw Torx (7) and remove strap guide rear 13mm (8).
- Remove side cover (5).
- Release counter-sunk screw Torx (2) and remove strap guide front 13 mm (1).
- Release counter-sunk screw Torx (4) and remove strap guide front 13 mm (3).
- Release cylinder screw Torx (10) and remove strap guide rear 13 mm (9).
- Fit side cover (5) (secure cylinder screw with screw locking varnish “medium-tight”). Install strap guide rear 16 mm (8).

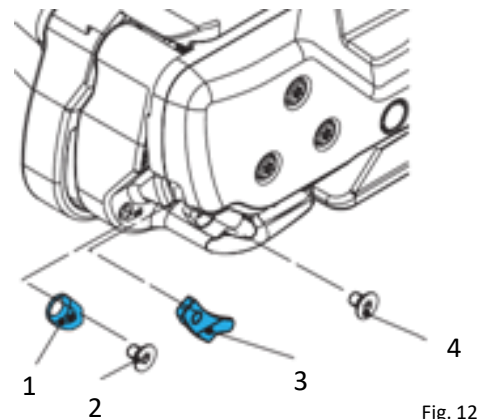

b) Change strap width from 15-16mm to 12-13 mm

- Release three cylinder screws Torx (6). Lift the rocker lever towards the handle, release cylinder screw Torx (7) and remove trap guide rear 16 mm (8).
- Remove side cover (5).
- Fit strap guide front 13 mm (1) (secure counter-sunk screw with screw locking varnish “medium-tight”).
- Fit strap guide front 13 mm (3) (secure counter-sunk screw with screw locking varnish “medium-tight”).
- Fit strap guide rear 13 mm (9) (secure cylinder screw with screw locking varnish “medium-tight”).
- Fit side cover (5) (secure cylinder screw with screw locking varnish “medium-tight”). Install strap guide rear 13 mm (8).

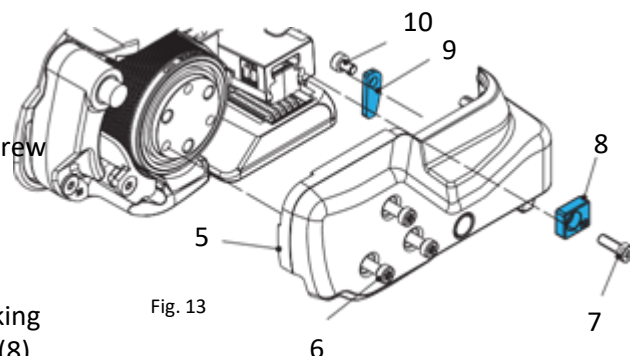

6.2 Switching on the control unit

1. Step

- Charge the battery pack as described under 5.2.
- Plug in the connector of the power cable (13) into the socket of the battery pack (7) and lock it by turning the red ring (12) clockwise.
- Lock the cover of the battery case again.
- Turn the main switch (11) to the right to operating mode “1”
- Set the operating mode switch (10) to operating mode “A”.



Fig. 14

12 13 7



Fig. 15

11 10 8

2. Step

2 LEDs (green and yellow) are now flashing. The control unit is in teaching mode.

Now move the joystick (8) completely to “move out” or “move in direction” and keep it pushed until the green LED permanently is shining (if the green **and** the yellow LED are shining, the battery is not fully charged but you nevertheless can continue).

The control unit/ sealing head is ready for operation.

6.3 Setting the strap tensioning range at the sealing head

Two strap tensioning ranges can be set at the sealing head:

**NORMAL = 400-1200N (713E); 900-2500N (726E); 1300-4500N (745E),
standard tension range for PET strap**

**SOFT = 150-750N (713E); 400-1360N (726E) bzw. 400-1600N (745E),
soft tension for PP straps**

Press "Soft" button (1).

The soft mode **is deactivated** when the "SOFT" display (2) changes position and is shown outlined.



Press "Soft" button (1).

The soft mode **is activated** when the "SOFT" display (3) changes position and is shown in bold.

The displayed tension force is reduced correspondingly.

On the left under the tension force an "S" (4) also appears.

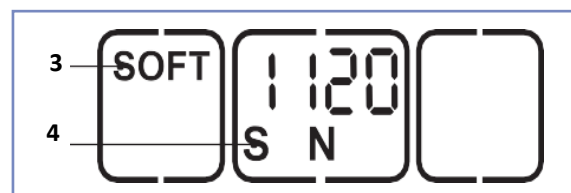

Fig. 16



Important!

Always use the SOFT tension mode when working with PP-strap!
By using the Soft mode, the tension wheel accelerates more slowly and avoids excessive strap waste when sealing with PP strap.

6.4 Setting strap tension at the sealing head

The set tension force is displayed continuously when the tool is ready for operation.

Press "Tension force" button (2).

- The set tension force flashes for 5 seconds.
- The + (1) and – (3) buttons appear.
- Unused displays disappear.
- Press the + (1) or – (3) button until the desired tension force is displayed.
- The status indicator bar (4) shows the set tension force in relation to the possible maximum value.
- Save: Press the "Tension force" button (2) or wait for 5 seconds.

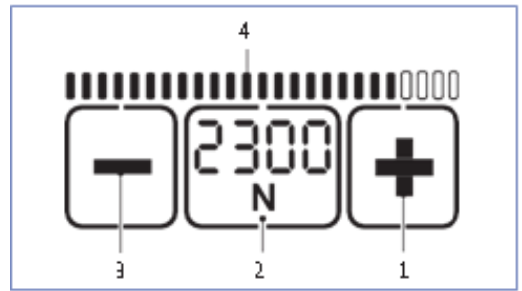

Fig. 17a

- Switch between display in "N" or "lbf": Press the flashing "Tension force" button (2) for two seconds.
- Every time the button is pressed an acoustic signal confirms the action.
- The tension force is displayed continuously when the tool is operational.
- Setting soft tension (Section 6.3).

713E										
Standard	N*	400	500	600	700	800	900	1000	1100	1200
	lbf*	90	110	135	155	180	200	225	250	270
Soft	N	150	225	300	375	450	525	600	675	750
	lbf	33	50	67	85	100	120	135	150	165

726E										
Standard	N*	900	1100	1300	1500	1700	1900	2100	2300	2500
	lbf*	200	250	290	340	380	430	470	520	560
Soft	N	400	520	640	760	880	1000	1120	1240	1360
	lbf	90	115	145	170	200	225	250	280	305

745E										
Standard	N*	1300	1700	2100	2500	2900	3300	3700	4100	4500
	lbf*	290	380	470	560	650	740	830	920	1000
Soft	N	400	550	700	850	1000	1150	1300	1450	1600
	lbf	90	120	160	190	225	260	290	325	360

(rounded values)

* N = Newton, lbf = pound-force per square inch

Warning! Adjusted tension force must relate to the goods to be strapped. Possible hazards caused by damages of dangerous goods or their packaging are not considered with the design of the strapping system.

6.5 Setting mode of operation at the sealing head

- Press the "Operating mode" button (1).
- Unused displays disappear.
- The currently set operating mode flashes for 5 seconds.
- + and – appear.
- Press the + (2) or – (3) button until the desired operating mode is displayed.

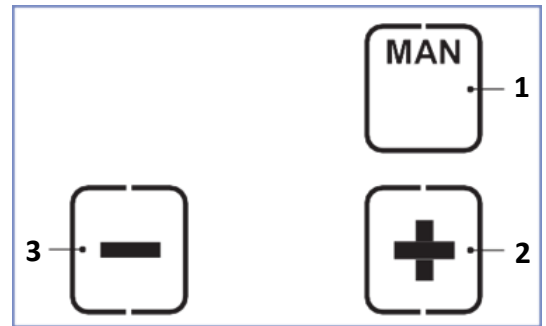

Fig. 17b

MAN / SEMI / AUTO

- By pressing the "Operating mode" button (1) again, or after waiting for a period of 5 seconds, the set mode is saved.

Every operating mode can also be selected for the "Soft tension" tension range (Side 24).

- **MAN-Manual**

The tensioning button must be pulled and held until the desired strap tension has been reached. The welding button must then be briefly pressed so that the straps are welded and the upper strap is cut off.

- **SEMI–Semi-automatic strapping (standard/factory setting)**

The tensioning button must be pulled and held until the set tension force has been reached. The straps are then automatically welded and the upper strap is cut off. It can be welded manually at any time by pressing the welding button.

- **AUTO–Fully automatic strapping***

The tensioning button has to be pulled (touched) once only. This triggers the tensioning process. Once the set tension force has been reached, the straps are automatically welded and the upper strap is cut off.

* This operating mode AUTO = Fully automatic strapping is factory blocked! Activation only through your ErgoPack service partner possible.



WARNING

Strap tensioning or strapping, danger of jamming and crushing

Do not place hands or other body parts between the strap and the packaged goods during the strapping process. Ensure that there are no other persons in the hazard zone

For an emergency stop in the case of danger (trapped person):

To release the strap tension (before welding), actuate the rocker lever. In operating mode AUTO, also the tensioning or welding button can be pressed again. After welding, cut the strap using a tool (strap cutter).

6.6 Select favourite*

The function „favourite“ activates a second settings level, whose parameters can be set freely like those of the main level.

This enables the operator to quickly change from one setting into the other.

Deactivate favourite:

- Press „favourite“ button (1).
The star (2) changes from bold to outlined. All parameters change to the pre-set values of this settings level.

Activate favourite:

- Press „favourite“ button (1). The star (3) changes from outlined to bold. All parameters change to the pre-set values of this settings level.
- The operating mode favourite is factory blocked! Activation only through your ErgoPack service partner possible.

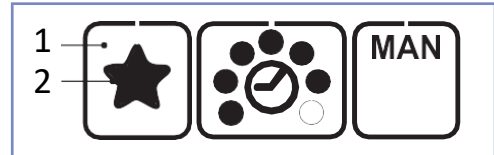

Fig. 17c

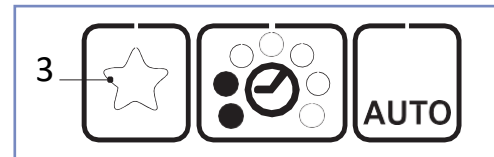

Fig. 17d

6.7 Changing strap coil

1. Step

Switch on the control unit key as described under point 6.2

2. Step

Set the operating mode switch (3) to position "B"
(green LED flashes / green and yellow LED are flashing if the battery is not fully charged)



Fig. 18

11 3 8

3. Step

You can use the joystick (8) to position the ChainLance so that the red chain link is in the middle of the sliding window (6).

The sliding windows must be closed during this operation!

4. Step

Open the sliding window (6). (red LED flashes quickly).

The control unit automatically switches off for safety reasons when the sliding window is open. Additionally, the main switch (11) has to be turned to the left into pos. „0“.

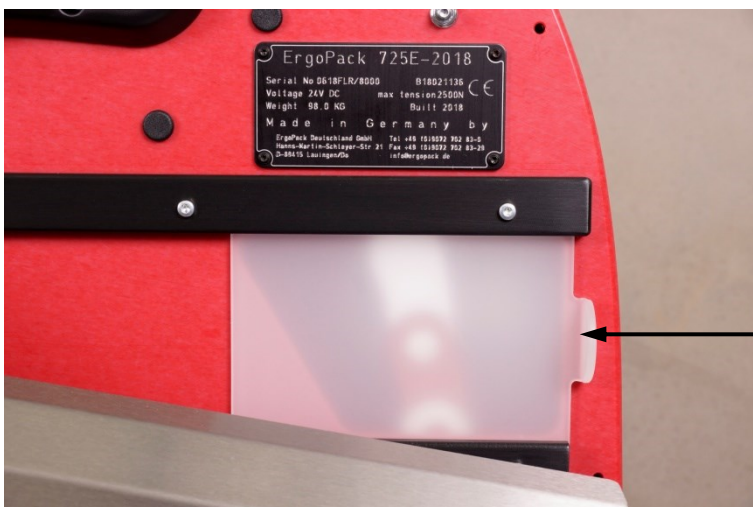

Fig. 19



Fig. 20

5. Step

Remove the pin for setting the pallet width from its position at 1,2 m.

To remove and to insert the pin, the button at the center of the pin must be pressed.



Fig. 21

6. Step

Put the pin into the hole with the milling groove at the lower left side.



Fig. 22

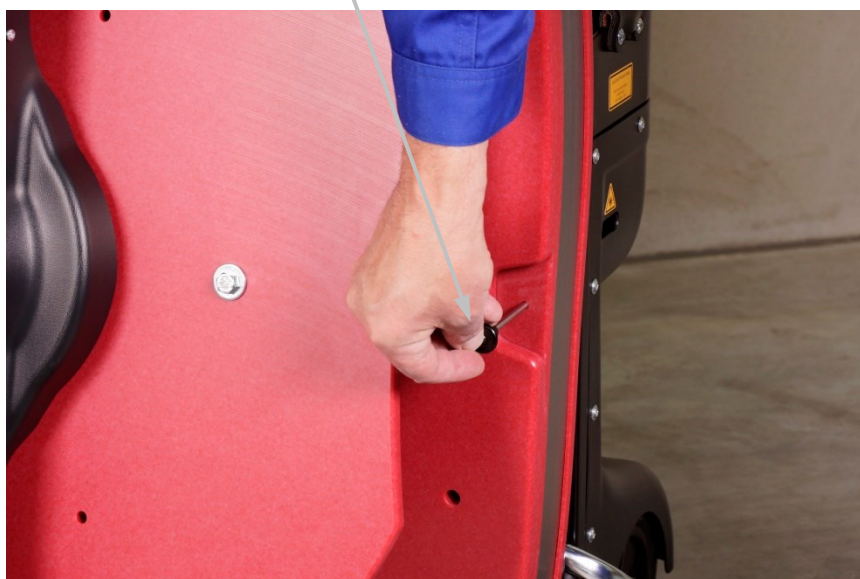

Fig. 23

7. Step

Fold down the pivot arm with the red circular disk until its final stop.



Fig. 24

8. Step

Place a new strap coil onto the red circular disk, that the strap uncoils in the **counter-clockwise direction** when looking down on the roll.



Fig. 25



Important!

Do not yet remove the tape or adhesive tape, which fix the strap on the coil!

9. Step

Fold up the arm with the strap coil again in its vertical position as shown on the picture.



Fig. 26

10. Step

Now, remove the tapes or adhesive tapes fixing the strap on the coil.



Fig. 27



Fig. 28

11. Step

Fold up the cover of the white roll for strap infeed, thread the strap through the U-bolt...



Fig. 29

...and over the white roll to the inside. Thereafter fold the cover back down again.



Fig. 30



Fig. 31

12. Step

Press from the left hand side on the metal clamp lock located in the red chain link...

...then slide the strap from the right to the left through the slot in the clamp lock.



Fig. 32



Fig. 33

Now close the sliding window (6). Make sure that the window is closed up to the stop. The safety switch for the control unit will only unlock again when the window is completely closed. (red flashing LED turns off, green LED lights up or green and yellow LED are lighting up)

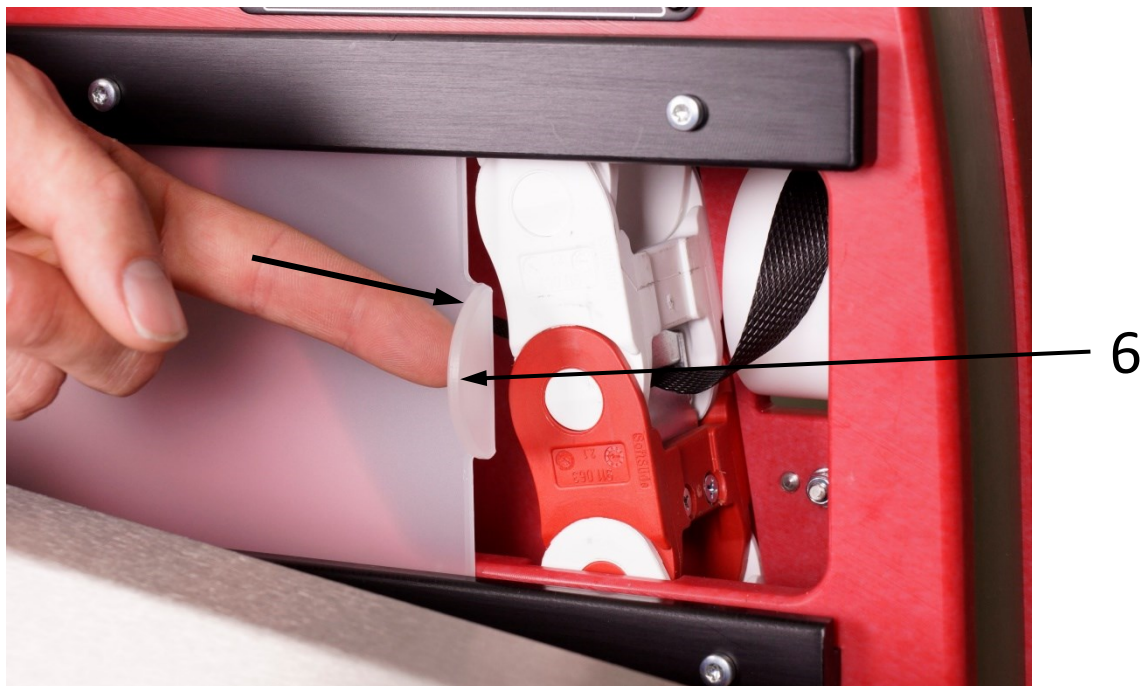

Fig. 34



13. Step

Press the joystick in the “move out “ direction until the reversing sledge tilts upwards.

Fig. 35



**Warning,
risk of injury!**

Never put your fingers between the chain links.



Hold the end of the ChainLance with the left hand while you still continue to push the joystick in the “move out direction“.

Fig. 36

Extend the ChainLance as far as shown on the picture.

Then put the chain on the strapping system...



Fig. 37



...and continue to move out the ChainLance until the red chain link is at about the same level as the left handle of the system.

Fig. 38



Fig. 39

14. Step

Remove the strap from the clamp lock in the red chain link and hold it straight up as shown.



Fig. 40



15. Step

Move the ChainLance back now by pushing the joystick in the „move in“ direction until the ChainLance is approx. 30 cm lower than the strap you are holding in your hand.



Fig. 41

16. Step

Open the eccentric latch in the red head piece of the ChainLance by pushing it inwards with your finger.



Fig. 42

Push the strap from the back through the head piece of the ChainLance (as shown). The strap must pass between the two aluminium eccentrics.



Fig. 43



17. Step

Now hold the strap vertically so that the strap and the ChainLance are straight.



Fig. 44

18. Step

Move the ChainLance completely backwards by pushing the joystick again in the “move in” direction.



Important !

Make sure that the strap remains continuously tensioned while moving back the ChainLance, to avoid the strap being pushed into the strapping system.



Fig. 45

19. Step

Set the operating mode switch (3) to position “A”

20. Step

Place the overlapping strap as shown with a loop through the small slot underneath the left handle.

3



Fig. 46



Fig. 47a



Fig. 47b

21. Step

Remove the pin for setting the pallet width from the hole with the milling groove...



Fig. 48

...and set the requested pallet width as shown on the picture by placing the pin into the next higher size of your pallet width.

Example 1:

Pallet width 0,80 m-
Put the pin into the 1,0 m position

Exampel 2:

Pallet width 1,2 m-
Put the pin into the 1,4 m position



Fig. 49

Your ErgoPack is now ready for strapping.

6.8 Strapping



Fig. 50

1. Step

Place the ErgoPack at a distance of approx. 30 cm in front of the pallet to be strapped.

If your system is equipped with the optional line laser:

Align the ErgoPack parallel to the pallet so that the laser line runs alongside the pallet edge.

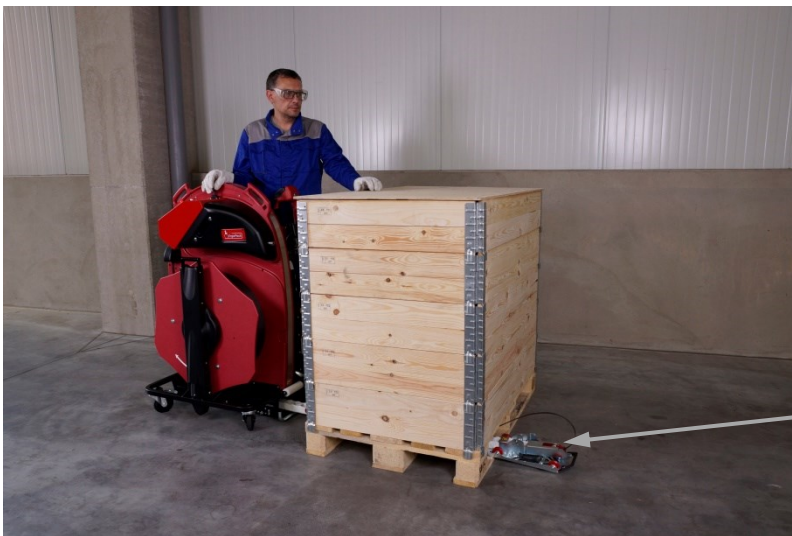

Fig. 51

2. Step

Move out the ChainLance by pushing the joystick in the “move out” direction.

The reversing sledge leads the strap through and underneath the pallet...



...and back up again on the opposite side.

Fig. 52

If the setting of the pallet width and the positioning of the strapping system are correct, the distance between the chain and the pallet is about 10 cm.

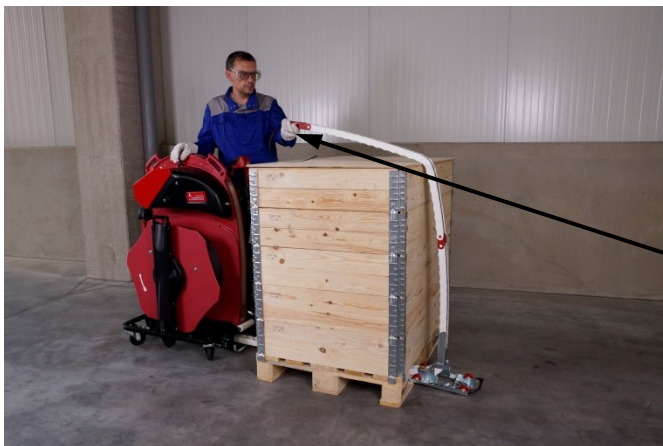

Fig. 53



Attention!

Push the joystick until the ChainLance appears on the other side and falls in your direction. Release the joystick, so that it returns to the neutral position (central position) and stops the ChainLance moving out further. Catch the ChainLance as shown at the red head piece. Do not let the ChainLance drop onto the package!

3. Step

Hold the strap with your left hand as shown, directly at the head piece of the ChainLance...

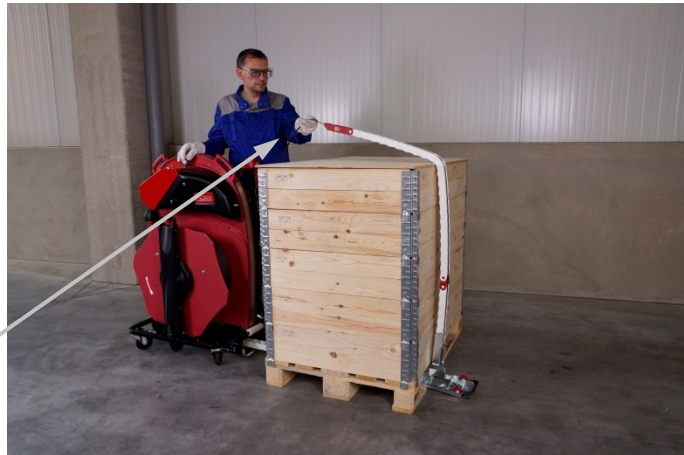

Fig. 54

... move the ChainLance completely back by pushing the joystick in „move in“ direction.

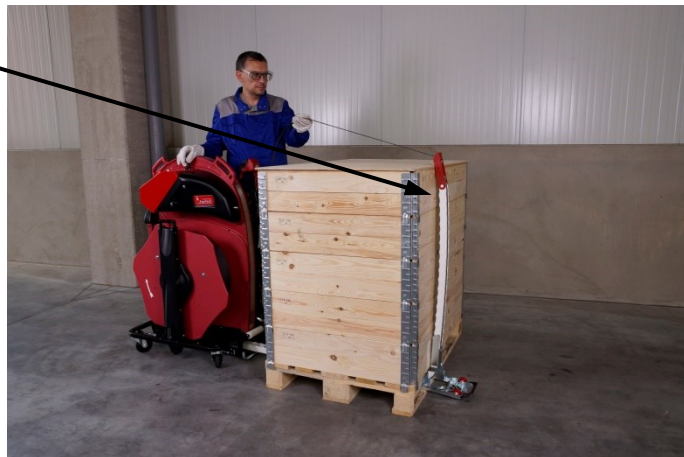

Fig. 55



Attention!

Always keep the strap slightly under tension when moving the ChainLance backwards, to avoid that loops can be formed at the reversing sledge. Loops may lead to malfunctions while moving back the ChainLance.

4. Step

The strap lifter comes up automatically when the reversing sledge moves back into the strapping system.

Now you have to loose the strap tension of your left hand; otherwise the strap lifter will not be able to come up.

The strap lifter lifts the second end of the strap up to working height so you can grasp it without bending down.

Only keep the joystick pushed until the strap lifter is fully in its upper position.

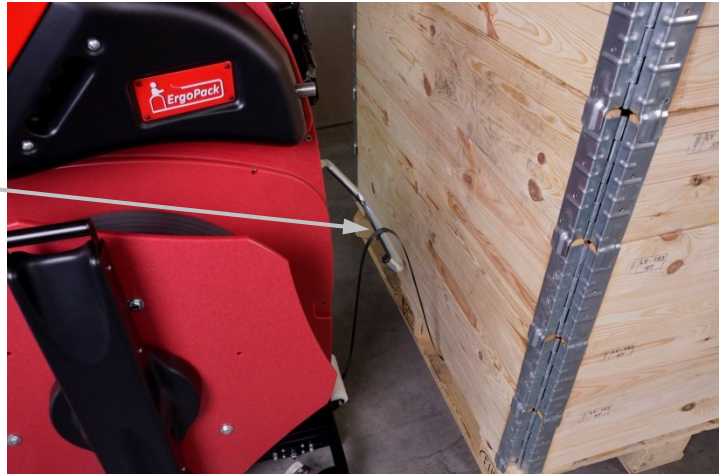

Fig. 56

The strap lifter automatically moves down again after 2 seconds. (The strap lifter will not go down automatically after 2 seconds if the upper position has not been reached successfully)



Attention!

You have to hold the strap loosely in your hand when the strap lifter comes up.

The strapping system automatically switches off to prevent damages if you do not release the strap once the strap lifter comes up. The strap lifter can be raised up again by repeatedly pushing the joystick in the “move in direction”.

If for sealing the strap you have to pull some additional strap out of the strapping system, do not take the strap directly at the strap lifter...



Fig. 57



Fig. 58a



Fig. 58b

...but about 10cm below the strap lifter. Hold the strap with the whole hand and pull it out of the strapping system. At the same time, you have to let the end of the strap slide through your other hand!

If your strapping system is equipped with the optional strap break relief: Before pulling at the strap, press down the foot pedal at the left side. This reduces the brake force of the strap coil and eases pulling out strap a lot.

6.9 Tensioning and sealing pallets above 70cm height

1. Step

Overlap the straps so that the end of the strap lies underneath.



Fig. 59

2. Step

Hold then both straps as shown with the **right hand**.

The end of the strap should lie in your hand and not project beyond it! hold



Fig. 60

3. Step

Push the sealing head towards the pallet with the left hand and tilt it forward at the same time so that the sealing head is parallel to the package.



Fig. 61

Pull the rocker lever to open the clamp of the sealing head.

With your right hand you can now feed the strap from the top to the bottom through the slot in the sealing head. (similar to a credit card)



Fig. 62

Now let go of the rocker lever



Fig. 63

4. Step

The tensioning and sealing of the strap is different according to the set mode (manual, semi-automatic or automatic mode)

See to this „Setting mode of operation“ page 26

4.1 Manual tensioning and sealing

Pull the tensioning button until the required tension force is reached (see page 26, chapter 6.5).

Thereafter, press the round welding button to weld both straps and to cut off the upper one.

4.2 SEMI-Semi-automatic tensioning and sealing

Pull the tensioning button until the pre-set tension force is reached. Afterwards, both straps will be automatically welded and the upper strap will be cut off. You can also weld the straps manually at any time by pressing the welding button even if the pre-set tension force was not reached.

4.3 Automatically tensioning and welding*

By a brief pulling (touching) of the tensioning button once, the sealing process (tensioning and welding) will be activated. Once the set tension force has been reached, the straps are automatically welded and the upper strap is cut off.

* This operating mode AUTO = Fully automatic strapping is factory blocked! Activation only through your ErgoPack service partner possible.



Fig. 64



Fig. 65



Warning!

Strap tensioning or strapping, danger of jamming and crushing

Do not place hands or other body parts between the strap and the packaged goods during the strapping process. Ensure that there are no other persons in the hazard zone.

For an emergency stop in the case of danger (trapped person):

To release the strap tension (before welding), actuate the rocker lever, the tensioning or welding button. After welding, cut the strap using a tool (strap cutter).

The tensioning process is finished, once the indicator bar is filled in fully.

The welding process is finished, once the indicator bar (1.) is filled fully.

The cool down starts (2.). After cool down there is a beep and the display lights up green.

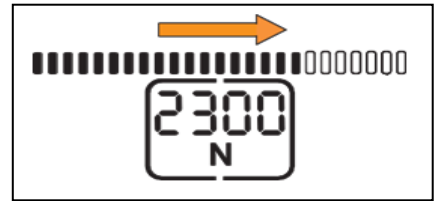

Fig. 66 a

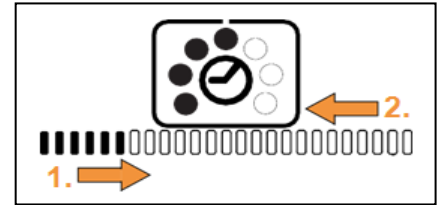

Fig. 66 b

5. Step

As soon as the countdown is finished and the signal has sounded you have to pull the rocker lever towards the handle.



Attention!

If after pressing the welding button, the welding does not start, but the sealing head beeps, the tensioning button was not pressed first.

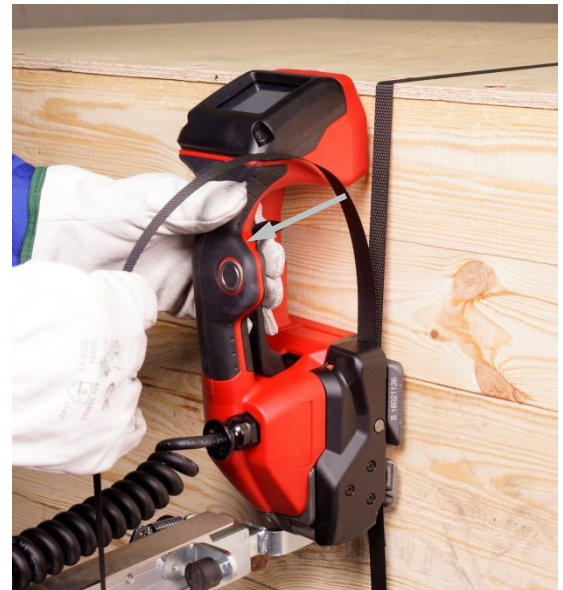

Fig. 67

6. Step

Now slew the sealing head to the left while keeping the rocker lever pulled.



Attention!

It is recommended to clean the sealing head regularly (daily), if there is a lot of strap waste. Especially the tension wheel and the tooth plate have to be checked for damages and kept clean. Please refer to point 7.8 , page 66

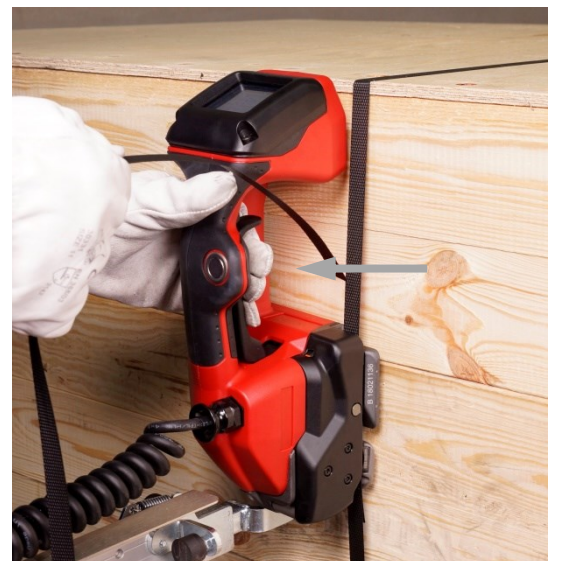

Fig. 68

6.10 Sealing control

Control the sealing regularly. The welding time must be checked in accordance with point 6.11 and changed if necessary when the straps are welded badly.

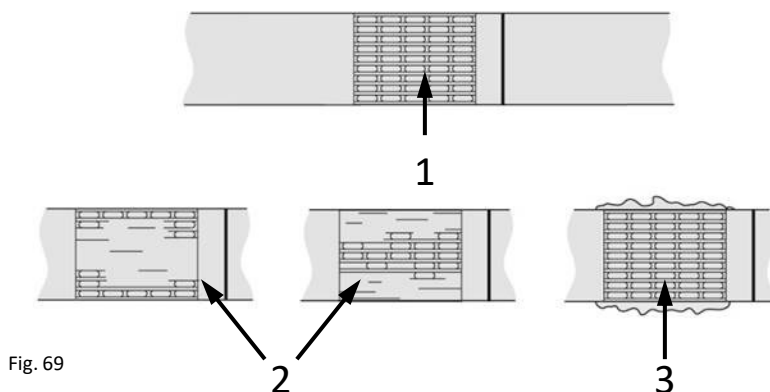

Fig. 69

1 Good welding: the whole sealed surface has been properly welded without any extra material being squeezed out to the side.

2 Bad welding: The surface has been unevenly welded, the selected welding time is too short.

3 Bad welding: Surplus material has squeezed out to the side, the selected welding time is too long.



Warning:

Improper welded straps cannot secure the loads and can therefore cause injuries.

Never transport or move goods with improper welded straps.

6.11 Setting the welding time

The set welding time is displayed continuously by filled dots when the system is ready for operation.

- press Button “welding time” (2)
- unused displays disappear.
- The filled dots of the current set welding time flash for 5 seconds.
- + and – appear.
- press button + (1) or – (3) until the desired welding time appears..
- Save: Press button “welding time” (2) or wait 5 seconds.

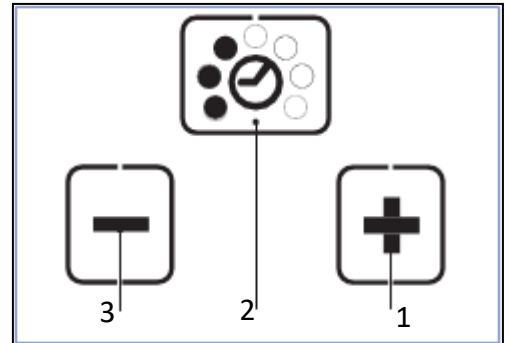

Fig. 70



Important!

If the necessary welding time is between 6 or 7 to produce a good welding according to point 6.10, there maybe a fault with the tool or worn components in the welding mechanism. Usually both tooth plates of the welding mechanism have to be replaced.

6.12 Tensioning and sealing of pallets below 70 cm height

1.Step

Pull out the black knob of the locking bolt. Afterwards, pull the sealing head forward out of the holder and place it on the package to be strapped.



Fig. 71

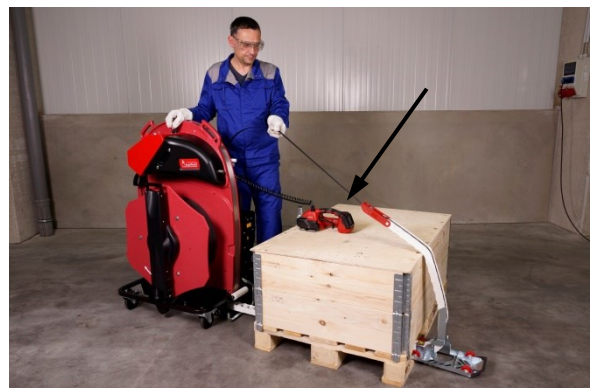

Fig. 72

Step 1-6 proceeds exactly as described under point 6.9, except that the locking tool is now in the horizontal position (Fig 73a-e)

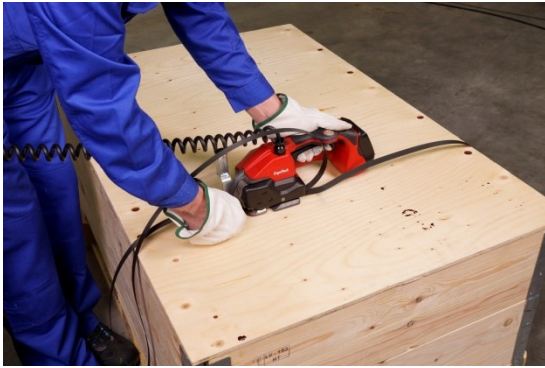

Fig. 73b

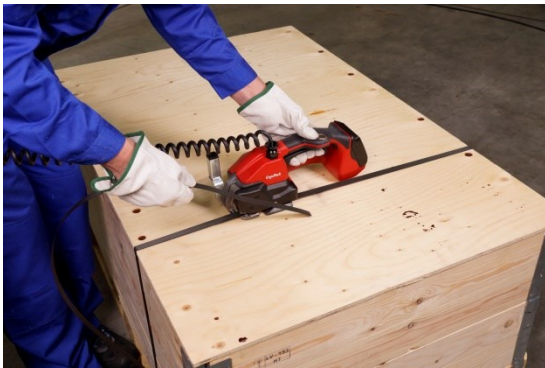

Fig. 73d



Fig. 73a



Fig. 73c



Fig. 73e

If your strapping system is equipped with the optional Triplex Tool-Lift:

Pull out the sealing head horizontally, slew the sealing head into horizontal position and put it on top of the pallet.

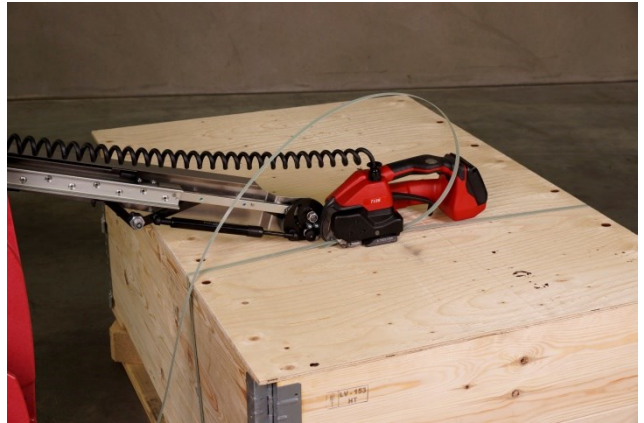

Fig. 74

7. Servicing and repair

Your ErgoPack is made out of galvanized steel, powder coated steel, stainless steel and highly wear resistant plastics and is basically maintenance free.

Clean the outside of the ErgoPack with a damp cloth if it is extremely dirty.



Warning!

During all maintenance and service/repair works, the strapping system has to be switched off by pressing the "OFF" switch, the key has to be removed from the main switch and the main power cable must be unplugged from the battery pack.

7.1 Cleaning the ChainLance

Clean the ChainLance with acetone or petroleum if it has become dirty with oil.



Attention!

Do not place the ChainLance into cleaner.
Never use lubricants like grease or oil!

7.2 Replacing the ChainLance

1. Step

Disconnect the main power cable from the battery pack.

2. Step

Pull out the reversing sledge by about 1 m, pull out the ChainLance of the strapping system as shown and roll it up.



Fig. 75

3. Step

Push the new ChainLance in again in reversed order of the removal.

4. Step

Reconnect the main cable to the battery pack again, set the main switch to position "1" and put the strapping system into operation in accordance with point 6.2, step 2.



Fig. 76

7.3 Replacing individual chain links

The ChainLance can be opened as described under point 7.4 to replace broken chain links.

A defective chain link can also be removed without the need to insert a new chain link. The control unit automatically adjusts to the new zero point in accordance with point 6.2, step 2, after each restart.

7.4 Replacing the reversing sledge

1. Step

Disconnect the main power supply cable from the battery pack.

2. Step

Pull the reversing sledge by about 1 m out of the strapping system, fold up the hinge at the reversing sledge and pull out approx. 60 cm of the chain upwards as illustrated.



Fig. 77

3. Step

Press a screw driver between the wings of two chain links (there is a small groove between the two wings to put the screw driver to) and slew the chain to the side until it fully separates.



Fig. 78



Fig. 79

4. Step

Push the ChainLance back into the strapping system until it has completely moved out of the reversing sledge.



Fig. 80

5. Step

Place the reversing sledge on its top as illustrated and use a screwdriver to unscrew both screws of the length adjusting belt.

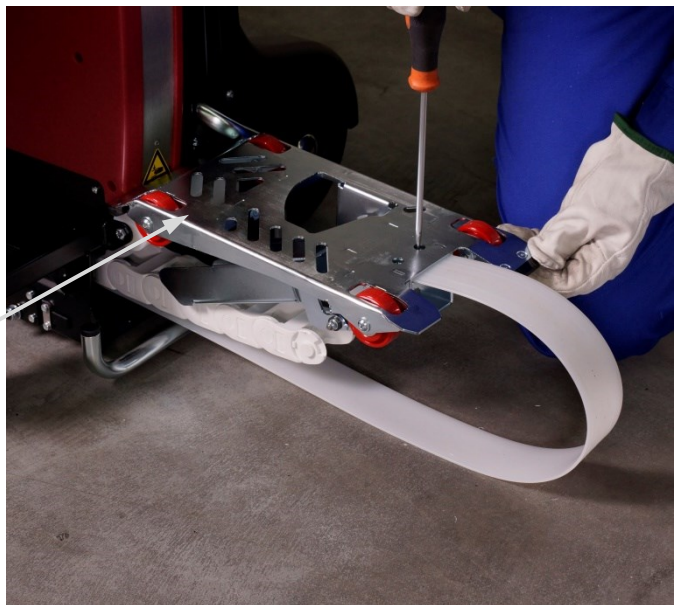

Fig. 81

6. Step

The fitting is done in the reversed order of the dismantling.



Important !

Both screws of the length stop strap must be protected with screw retaining varnish!

7.5 Replacing the length adjusting belt

1. Step (dismantling)

Perform steps 1 to 5 listed in point 7.4 and continue with step 2.

2. Step (dismantling)

Remove these 6 screws of the cover with **a screw driver PZ2** and remove the two covers.

Thereafter, remove these 3 screws (4mm allen wrench and 8mm open-end wrench on opposite side....

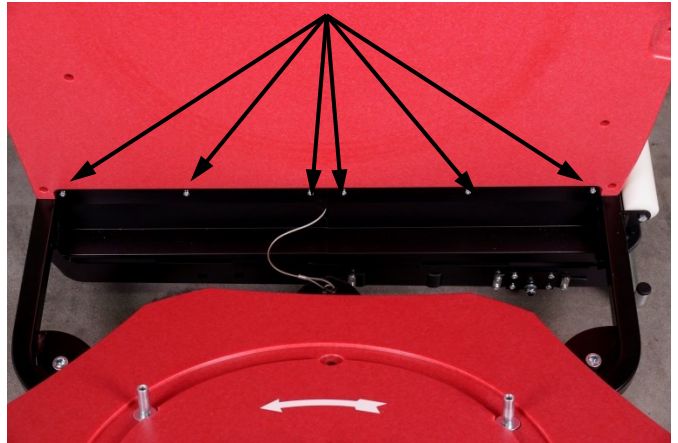

Fig. 82



Fig. 83

...not the hexagon socket screws with a 5mm Allen wrench and a 10mm open end wrench on the opposite side!

3. Step (dismantling)

Remove the pin for setting the pallet width and pull out the length adjusting belt.

4. Step (installation)

Push the ChainLance all the way back into the strapping system so that you can see the groove of the length adjusting belt.

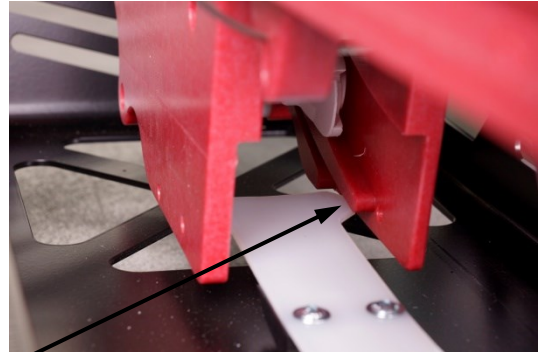

Fig. 84

5. Step (installation)

Push the new length adjusting belt into the small groove below the groove for the ChainLance.

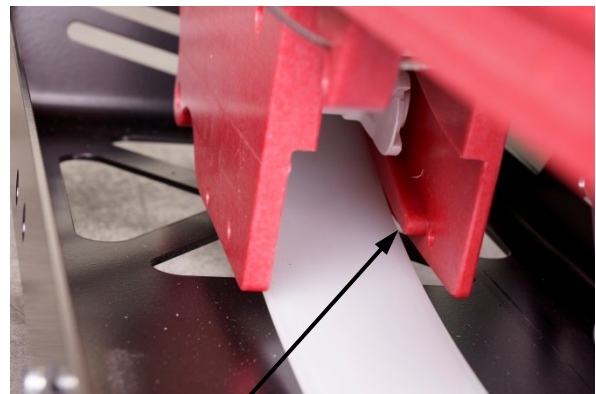

Fig. 85



Important !

Make sure that also the cut out of the length adjusting belt is inserted into the lower groove and that it does not slide into the upper groove of the ChainLance. Further assembling is to be done in reversed dismantling order.

The screws may only be tightened until the stop nut engages. The screws have to be loose and must not be tightened!

If the screws have been tightened too much, the storage plates will be pressed together, the ChainLance and the length adjusting belt could become jammed!

7.6 Changing the sealing head



Fig. 86

1. Step

Remove the cover by pulling at the handle.
(the cover is fixed by magnets).

2. Step

Turn the red ring of the plug counter clockwise and remove the red plug.



Fig. 87

3. Step

Remove the 4 screws of the red metal cover at the operator's side.



Fig. 88

4. Step

Pull the cable with the plug through the opening in the storage plates.



Fig. 89

5. Step

Pull out the locking bolt for unlocking the sealing head and remove the sealing head.



Fig. 90

If your unit is equipped with the optional Triplex-Tool-Lift:

Remove both screws M5 (4mm Allen wrench). These screws are secured with special wedge-lock washers (The wedge-lock washers can be reused).



Fig. 91

6. Step

The mounting of the sealing head is to be done in reversed order of the dismantling.

When mounting the cover of the control unit, take care to engage it first at the level of the cutter and then all along the groove.



When mounting the sealing head again make sure that the rough tooth system of the two wedge-lock washers are facing (Fig. 92)

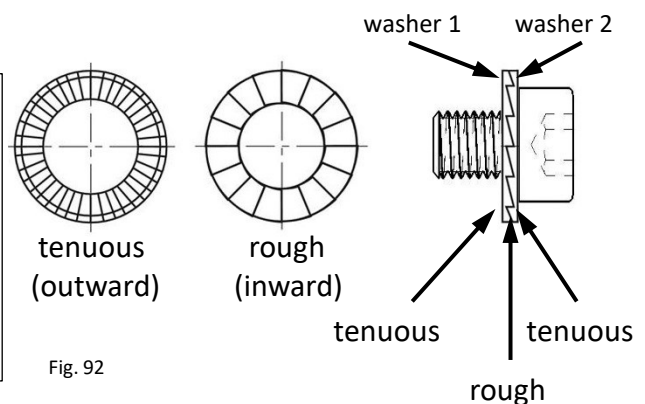

Fig. 92

7.7 Changing the control box with the motor

1. Step

Remove the cover by pulling at the handle.
(the cover is fixed by magnets).



Fig. 93

2. Step

Remove all three plugs on the lower side of the control unit. (4 plugs if optional laser is installed)
All three plugs are secured with a safety ring which is unlocked by turning it counterclockwise.



Fig. 94

3. Step

Remove the 4 screws of the pocket for the manual and the 2 small cover caps.



Fig. 95



Fig. 96

4. Step

First remove the four screws around the drive shaft by using a 4mm Allen wrench.

To do so, you have to move the ChainLance to turn the gear wheel until you can see and open the individual screws.



Fig. 97

5. Step

Remove the fifth screw now and hold the control unit simultaneously.

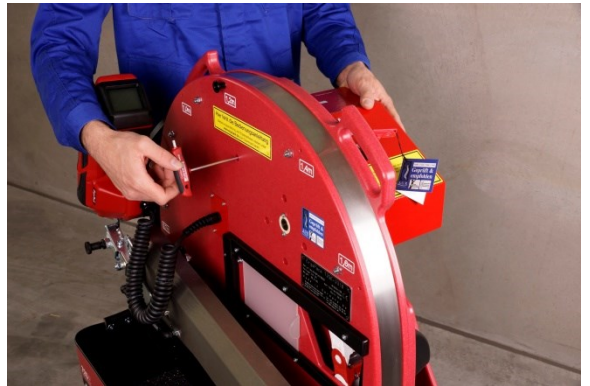

Fig. 98

6. Step

Pull off the control unit. Make sure that the small fitting spring on the drive shaft does not get lost.

7. Step

The installation of the control unit is done in the reversed order of the disassembling.



Fig. 99

7.8 Cleaning/replacing the tensioning wheel at the sealing head

Cleaning the tension wheel without disassembling

- There is an access hole (100a) in the protection cover below the motor. The tension wheel and the tooth plate can be cleaned with compressed air through this access hole.
- When heavily soiled, the tension wheel has to be disassembled.



Fig. 100

100a



Warning !

Wear eye protection when cleaning with compressed air!

Cleaning the tension wheel with disassembling / replacing the tension wheel

Release 4 cylinder screws (Torx) (4), remove strap guide rear (5) and side cover (3).

- Remove tension wheel (1) carefully.
- Remove ball bearing (2) from tension wheel.
- Clean the tension wheel with compressed air.
- If the tension wheel teeth are covered with heavy dirt they must be cleaned carefully with the wire brush (6) supplied.
- Check tension wheel for worn teeth. If a few teeth are broken, replace tension wheel (observe direction, see arrow).

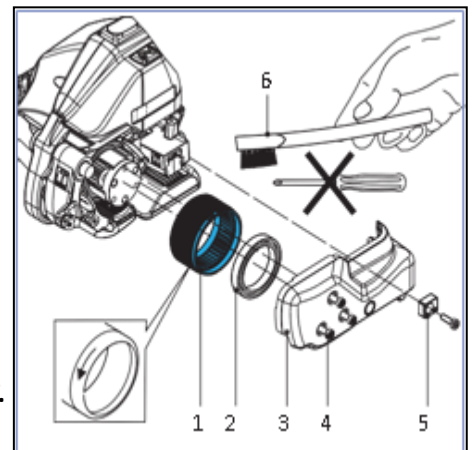

Fig. 101

- **Installation** is done in the reversed order of the disassembling.
- Grease interior gear teeth of the tension wheel lightly with Klüber grease GBU Y 131 (Microlube).



Attention!

The tension wheel is extremely sensitive when it comes into contact with hard, especially metallic objects. A hard object, such as a screwdriver or similar, must not be used under any circumstances whatsoever for cleaning. The tension wheel must not be cleaned in an installed state when it is rotating. Risk of breakage teeth.

7.9 Cleaning/replacing the tooth plate at the sealing head



Warning !

Wear eye protection when cleaning with compressed air!

- Remove pan head screw (1).
- Lift the rocker lever towards the handle and remove tooth plate (2).
- Clean tooth plate with compressed air.
- If the tooth plate teeth are covered with heavy dirt, they must be cleaned carefully with the wire brush supplied.
- Check tooth plate for worn teeth, if necessary, replace tooth plate.
- **Installation** is done in the reversed order of the disassembling.
- Secure pan head screw (1) with screw locking varnish "medium-tight".

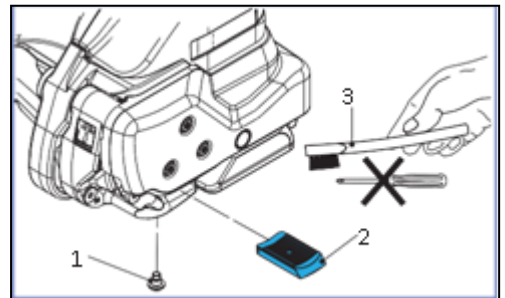

Fig. 102



Attention!

The tooth plate (2) must be placed so that it can move freely in the rocker!

7.10 Replacing the cutter at the sealing head

- Release 4 cylinder screws Torx (3), remove strap guide rear (4) and side cover (2).
- Release cylinder screw Torx (5), take care that you do not lose the compression spring (7), remove knife (1) with flanged bushing (6) and replace knife.

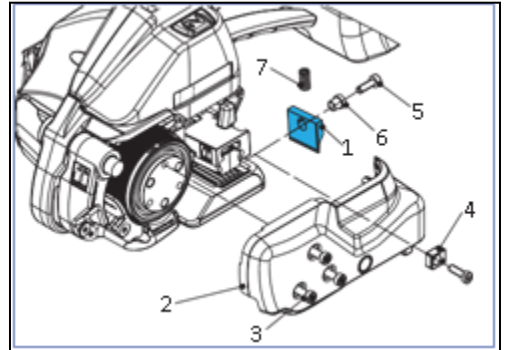

Fig. 103

- **Installation** is done in the reversed order of the disassembling.
- Before installing the knife (1), check that the compression spring (7) on top of the knife is still mounted.
- Secure the pan head screw (5) with screw locking varnish "medium-tight".

8. Safe moving and parking

Moving the strapping system

The strapping system can be pushed in an upright position with the two hand grips at the head of the red frame plate. For pushing it you must release the brakes of the two guide rolls on the strap side.

Parking the strapping system

After having parked the strapping system you have to lock up the brakes of the two guide rolls on the strap side of the strapping system to avoid that the strapping system is rolling away accidentally. Furthermore, you have to make sure that the ChainLance is completely drawn in and that the key of the main switch is removed and kept safely from the access of unauthorized persons.

10. General safety warnings for power tools



WARNING! Read all safety warnings and all instructions.

Failure to follow the warnings and instructions may result in electric shock, fire and/or serious injury.

Save all warnings and instructions for future reference.

The term “power tool” in the warnings refers to your mains-operated (corded) power tool or battery-operated (cordless) power tool.

Work area safety

- a) **Keep the work area clean and well lit.** Cluttered or dark areas invite accidents.
- b) **Do not operate power tools in explosive atmospheres, such as in the presence of flammable liquids, gases or dust.** Power tools create sparks which may ignite the dust or fumes.
- c) **Keep children and bystanders away while operating a power tool.** Distractions can cause you to lose control.

Electrical safety

- a) **Power tool plugs must match the outlet. Never modify the plug in any way. Do not use any adapter plugs with earthed (grounded) power tools.** Unmodified plugs and matching outlets will reduce the risk of electric shock.
- b) **Avoid body contact with earthed or grounded surfaces such as pipes, radiators, ranges and refrigerators.** There is an increased risk of electric shock if your body is earthed or grounded.
- c) **Do not expose power tools to rain or wet conditions.** Water entering a power tool will increase the risk of electric shock.
- d) **Do not abuse the cord. Never use the cord for carrying, pulling or unplugging the power tool. Keep the cord away from heat, oil, sharp edges or moving parts.** Damaged or entangled cords increase the risk of electric shock.
- e) **When operating a power tool outdoors, use an extension cord suitable for outdoor use.** Use of a cord suitable for outdoor use reduces the risk of electric shock.
- f) **If operating a power tool in a damp location is unavoidable, use a residual current device (RCD) protected supply.** Use of an RCD reduces the risk of electric shock.

Personal safety

- a) **Stay alert, watch what you are doing and use common sense when operating a power tool. Do not use a power tool while you are tired or under the influence of drugs, alcohol or medication.** A moment of inattention while operating power tools may result in serious personal injury.
- b) **Use personal protective equipment. Always wear eye protection.** Protective equipment such as dust masks, non-skid safety shoes, hard hat, or hearing protection used for appropriate conditions will reduce personal injuries.
- c) **Prevent unintentional starting. Ensure the switch is in the off-position before connecting to the power source and/or battery pack, picking up or carrying the tool.** Carrying power tools with your finger on the switch or energising power tools that have the switch on invites accidents.
- d) **Remove any adjusting key or wrench before turning the power tool on.** A wrench or a key left attached to a rotating part of the power tool may result in personal injury.
- e) **Do not overreach. Keep proper footing and balance at all times.** This enables better control of the power tool in unexpected situations.
- f) **Dress properly. Do not wear loose clothing or jewellery. Keep your hair, clothing and gloves away from moving parts.** Loose clothes, jewellery or long hair can be caught in moving parts.
- g) **If devices are provided for the connection of dust extraction and collection facilities, ensure these are connected and properly used.** Use of dust collection can reduce dust-related hazards.

Power tool use and care

- a) **Do not force the power tool. Use the correct power tool for your application.** The correct power tool will do the job better and safer at the rate for which it was designed.
- b) **Do not use the power tool if the switch does not turn it on and off.** Any power tool that cannot be controlled with the switch is dangerous and must be repaired.
- c) **Disconnect the plug from the power source and/or the battery pack from the power tool before making any adjustments, changing accessories, or storing power tools.** Such preventive safety measures reduce the risk of starting the power tool accidentally.
- d) **Store idle power tools out of the reach of children and do not allow persons unfamiliar with the power tool or these instructions to operate the power tool.** Power tools are dangerous in the hands of untrained users.
- e) **Maintain power tools. Check for misalignment or binding of moving parts, breakage of parts and any other condition that may affect the power tool's operation. If damaged, have the power tool repaired before use.** Many accidents are caused by poorly maintained power tools.
- f) **Keep cutting tools sharp and clean.** Properly maintained cutting tools with sharp cutting edges are less likely to bind and are easier to control.
- g) **Use the power tool, accessories and tool bits etc. in accordance with these instructions, taking into account the working conditions and the work to be performed.** Use of the power tool for operations different from those intended could result in a hazardous situation.

Battery tool use and care

- a) **Recharge only with the charger specified by the manufacturer.** A charger that is suitable for one type of battery pack may create a risk of fire when used with another battery pack.
- b) **Use power tools only with specifically designated battery packs.** Use of any other battery packs may create a risk of injury and fire.
- c) **When the battery pack is not in use, keep it away from other metal objects, like paper clips, coins, keys, nails, screws or other small metal objects, that can make a connection from one terminal to another.** Shorting the battery terminals together may cause burns or a fire.
- d) **Under abusive conditions, liquid may be ejected from the battery; avoid contact. If contact accidentally occurs, flush with water. If liquid contacts eyes, additionally seek medical help.** Liquid ejected from the battery may cause irritation or burns.

Service

- a) Have your power tool serviced by a qualified repair person using only identical replacement parts.** This will ensure that the safety of the power tool is maintained.

