



Original Operating Instructions

**For ErgoStrap
700X-Li/713X-Li/726X-Li/745X-Li**

US

Declaration of conformity

EU declaration of conformity (for the purposes of the EU machine directive 2006/42/EG)

We, ErgoPack Deutschland GmbH
Hanns-Martin-Schleyer Str. 21
89415 Lauingen

hereby declare, that the Ergonomic Pallet Strapping Systems type "ErgoStrap 700X-Li, 713X-Li, 726X-Li, 745X-Li", to which this declaration refers, complies with the respective relevant and basic health and safety requirements of the EU directives because of their concept, type of construction and the model we have brought on to the market.

This declaration loses its validity if a change is made to the system without our permission.

Respective
EU directives: EU Machine directive (2006/42/EG)
EU Guideline on electromagnetic compatibility
(2014/30/EU)

Applied standards EN 12100: 2010
EN 415-1: 2014
EN 415-8: 2008
EN 61000-4-3: 2006
EN 55011: 2016

Since strapping system: 0421HXXX/11505
Since year of manufacture: 2021

Lauingen, 27th of April, 2021

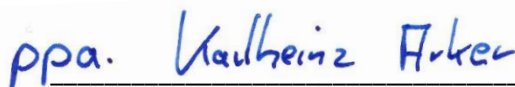

Karlheinz Arker
Technical Director

Authorised representative for publishing technical documentation:
ErgoPack Deutschland GmbH
Hanns-Martin-Schleyer-Str. 21
D-89415 Lauingen

Declaration of conformity

UK Declaration of Conformity

We, ErgoPack Deutschland GmbH
Hanns-Martin-Schleyer Str. 21
89415 Lauingen, Germany

hereby declare, that the Ergonomic Pallet Strapping Systems type "ErgoPack 700X-Li, 713X-Li, 726X-Li, 745X-Li", to which this declaration refers, comply with the respective relevant and basic health and safety requirements of the United Kingdom directives because of their concept, type of construction and the strapping systems we have brought on to the market.

This declaration loses its validity if a change is made to the system without our permission.

Respective United Kingdom directives: Supply of Machinery (Safety) Regulations 2008 (UK SI 2008 No. 1597)
Electromagnetic Compatibility Regulations 2016 (UK SI 2016 No. 1091)

Applied standards BS EN ISO 12100: 2010
BS EN 415-1: 2014
BS EN 415-8: 2008
BS EN 61000-4-3: 2006
BS EN 55011: 2016

Since strapping system: EP1015XXXX
Since year of manufacture: 2022

Lauingen, 5th of April, 2022

Karlheinz Arker
Technical Director

Authorised representative for publishing technical documentation:
ErgoPack Deutschland GmbH
Hanns-Martin-Schleyer-Str. 21
D-89415 Lauingen

Table of contents

1.	Validity of the operating instructions	7
2.	General	8
2.1	Moving the strapping system	8
2.2	Parking the strapping system	8
2.3	Work area space requirement	9
2.4	Environmental conditions	9
2.5	Energy supply Li-ion charger/battery	10
2.6	Notes on environmental protection	11
2.6.1	Disposing of the Li-ion battery	11
2.7	Notes on transport	12
2.7.1	Shipping the Li-ion battery	12
2.7.2	Transporting the Li-ion battery on the road	12
2.8	Meaning of warning symbols, presentation conventions	13
2.8.1	Explanation of symbols	13
2.8.2	Explanation of the safety representation	14
3.	Recommendations for protective measures	15
3.1	Safety regulations for battery and charger	16
3.1.1	General safety instructions for Li-ion batteries	17
3.1.2	General safety instructions Charger	17
3.1.3	Safety instructions for charging	18
3.1.4	Safety instructions for cleaning the battery and charger	18
3.1.5	Safety instructions for the storage of the Li-ion battery	19
3.1.6	Safety instructions for implant carriers	19
4.	Description	20
4.1	Design	20
4.2	Control panel strapping system	21
4.3	Touch display strapping system	21
4.4	Control panel sealing head	22
4.5	Li-ion battery	23
4.5.1	General view Li-ion battery	23
4.5.2	LED display Li-ion battery	24

4.6	Display and commissioning of the Li-ion battery chargingstation/charger	25
4.6.1	General view Li-ion battery charging station	26
4.6.2	General view Li-ion battery charger	26
4.6.3	Commissioning Li-ion battery charging station/charger	27
5.	Technical data	28
5.1	Strapping system	28-29
5.2	Sealing head	29-30
5.3	Li-ion battery	31
5.4	Li-ion battery - Charging station/charger	32
6.	Intended use	33
7.	Commissioning	34
7.1	Li-ion battery-charging station/charger	34
7.2	Charging the Li-ion battery	34-36
7.3	Setting strap width at the sealing head	37
7.4	Switching on the strapping system	38
7.5	Setting the date and time	39-40
7.6	Setting strap tension range at the sealing head	41
7.7	Setting strap tension at the sealing head	42-43
7.8	Setting mode of operation at the sealing head	44-45
7.9	Select favourite	45
7.10	Setting welding time	46
7.11	Changing strap coil	47-55
7.12	Setting pallet width	56
8.	Operation	57
8.1	Strapping	57-61
8.2	Tensioning and sealing of pallets heighs over 27"	62-65
8.3	Sealing control	66
8.4	Tensioning and sealing pallets below 27" height with ErgoStrap standard Tool-Lift	67-69
9.	Risks	70-73
9.1	Emergency information	73
9.1.1	First aid measures	73
9.1.2	Firefighting measures	74

10.	Service and repair	75
10.1	Cleaning the ChainLance	75
10.2	Replacing the ChainLance	76-80
10.3	Replacing the reversing sledge	81-83
10.4	Replacing individual chain links	84
10.5	Replacing the length adjusting belt	85-86
10.6	Changing the sealing head	87-89
10.7	Changing the control box joystick unit	90-94
10.8	Changing the control box display unit	95-96
10.9	Changing the motor	97-100
10.10	Cleaning/replacing the tension wheel at the sealing head	101-102
10.11	Cleaning/replacing the tooth plate at the sealing head	102
10.12	Replacing the cutter at the sealing head	103
10.13	Li-ion Battery Error Messages and cleaning	104
10.14	Li-ion Charging Station/Charger Error messages and cleaning	105
11.	Software Updates	106-108
12.	Personal protective equipment	109
13.	General safety warnings for power tools	110-113

1. Validity of the operating instructions

The operation in these instructions is explained by using the ErgoStrap 726X-Li as an example.

All points in these instructions referring to the operation of the sealing head are not applicable as far as the "ErgoStrap 700X-Li" is concerned.

These operating instructions are valid for the following models:

ErgoStrap 700X-Li

Strapping system with electrical drive, electronically controlled via joystick, without sealing head

ErgoStrap 713X-Li

Strapping system with electrical drive, electronically controlled via joystick, with a sealing head for strap width of 3/8"-1/2" and a maximum tension force of 270 lbf.

ErgoStrap 726X-Li

Strapping system with electrical drive, electronically controlled via joystick, with a sealing head for strap width of 1/2" -5/8" and a maximum tension force of 560 lbf.

ErgoStrap 745X-Li

Strapping system with electrical drive, electronically controlled via joystick, with a sealing head for strap width of 5/8"-3/4" and a maximum tension force of 1000 lbf.

2. General

2.1 Moving the strapping system

The strapping system can be pushed in an upright position with the two hand grips (Fig.1). For pushing it you must release the brakes of the two guide rolls on the strap side (Fig.1a).

2.2 Parking the strapping system

After having parked the strapping system you have to lock up the brakes of the two guide rolls (Fig.1a) on the strap side to avoid that the system is rolling away accidentally.

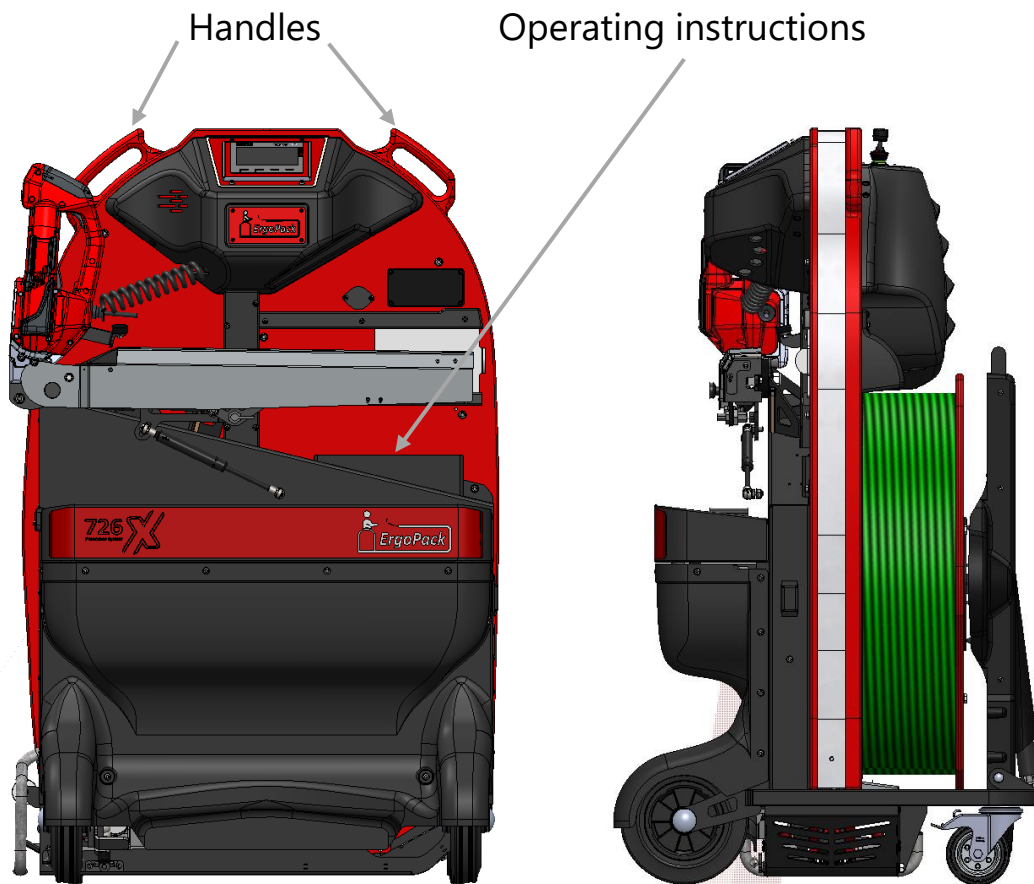

Fig. 1

Fig. 1a

Guide roll with
parking brake

2.3 Work area space requirement

For a safe operation while strapping, the system has to be positioned correctly in front of the pallet. Therefore, a free area of at least 43" width in front of the pallet to be strapped is required.

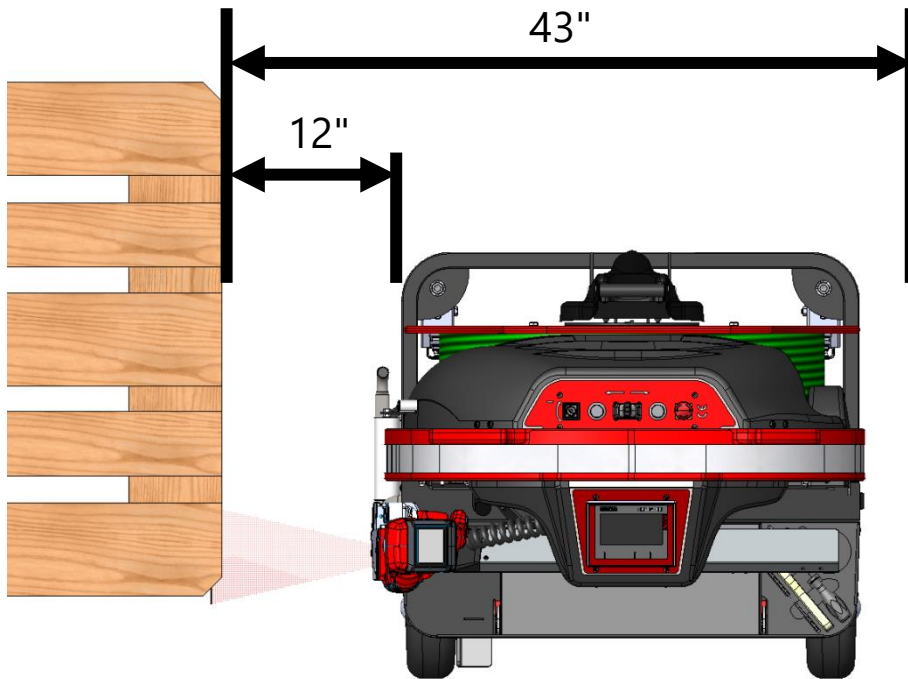

Fig. 2

2.4 Environmental conditions

The strapping system is only to be used in a covered dry area, otherwise the risk of an electric shock can not be ruled out. The ambient temperature during operation must not exceed 122°F and not fall below 32°F.

For the strapping system, an electrically conductive floor is recommended.

2.5 Energy supply Li-ion charger/battery

Li-ion charger

	wide range charger
Operating voltage:	100-240 V
	50/60 Hz
Rated power consumption:	up to approx. 650W
Charging current (nominal):	up to 10A

Li-ion battery

Weight:	approx. 11 lbs
Charging time:	approx. 3,5 hours
Voltage (nominal):	36,3 V
Capacity (nominal):	24,15 Ah
Working temperatur range:	32°F to 104°F
Numbers of strappings:	Up to 1200 strappings with standard strapping*
Service life:	approx. 80% residual capacity after approx. 1000 charging cycles

***standard strapping:**

Battery pack: 100 charging and discharging cycles

Tape: 1/2" PET (full strap coil)

Sealing head: 726X, tension force 200 lbf without setting the SOFT tension mode, welding time 2nd range

Pallet: pallet width 32" , pallet height 45"

Strapping speed: fast

Room temperature: 68°F

2.6 Notes on environmental protection

Physical or chemical materials injurious to health have not been used for manufacturing the strapping system.

Concerning the waste disposal, valid national rules and regulations have to be considered. Take care about disposing packaging, the product itself and parts accordingly.

2.6.1 Disposal of the Li-ion battery

Do not dispose of the Li-ion battery in household waste. It must be disposed of properly and in an environmentally friendly manner by a disposal company. Disposal may vary from region to region or may be subject to country-specific regulations. To avoid short circuits, discharge the battery completely and tape the terminals with adhesive tape.

If the rechargeable battery is not disposed of properly, it may cause a fire and leakage of substances that are hazardous to health and the environment.

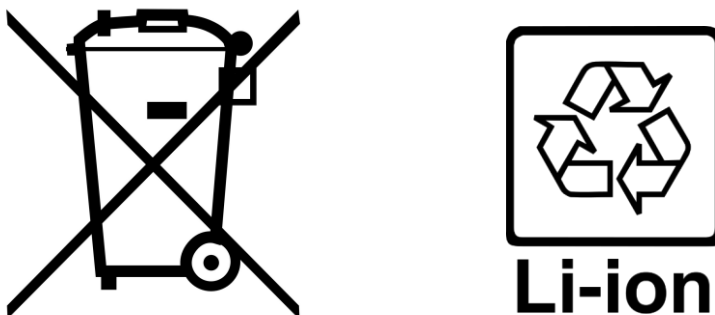

Fig. 3

2.7 Notes on transport

2.7.1 Shipping the Li-ion battery pack

The Li-ion battery is considered dangerous goods and may only be packed and shipped by trained persons. Please contact your ErgoStrap service partner in this regard.

2.7.2 Transporting the Li-ion battery on the road

Private users may transport the battery on the road without any restrictions.

Commercial users or third parties carrying out transport must observe the relevant dangerous goods requirements for lithium-ion batteries.

2.8 Meaning of warning symbols, presentation conventions

2.8.1 Explanation of symbols



General warning sign



Warning of explosion and fire caused by short circuit, overheating or other electrical/mechanical misuse



Warning against laser radiation



Warning of crushing hazards



No open flame or high heat. Danger of explosion and fire.



Do not operate for persons with pacemakers or implanted defibrillators.



Compliant with the relevant European directives



Symbol for lithium-ion batteries (contains recyclable material)

Li-ion

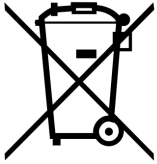

Do not dispose of in household waste



Follow instructions

2.8.2 Explanation of the safety representation



Warning!

Marks a hazard with moderate risk.
If not avoided, it can result in death or serious injury.



Caution!

Marks a hazard with a minor risk.
If not avoided, it can result in a minor or moderate injury.



Attention!

Marks a situation to be considered.
If not considered, it can lead to material damage or poor operating results.



Note!

Marks useful, additional information.

3. Recommendations for protective measures

These operating instructions will help you to understand the strapping system and how to use it according to regulations. The operating instructions contain important notes on how to use the strapping system safely, properly and economically.

Adhering to the notes helps you to avoid dangers, repairs and down times and also increases the reliability and life span of the strapping system.



Note!

The operating instructions must be available at the place where the strapping system is used (below the sliding window, Fig. 1). Before using the strapping system for the first time, the operating instructions have to be read, understood and used by everybody who works with the system. These works include operation, maintenance and repair!
See chapter 8 and chapter 10.

In addition to the operating instructions and the rules in the country and place of use for the prevention of accidents, the recognized special rules for working safely and according to proper and professional standards also have to be respected.

In order to protect the strapping system against unauthorized access, it is recommended to remove the key from the main switch and remove the Li-ion battery from the strapping system.

The key should be kept safe from unauthorized access.

3.1 Safety regulations for battery and charger

Lithium-ion batteries can e.g. drop, explode and burn if handled improperly. Observe the safety instructions point 3.1 to 3.1.6 to minimise the risk.

- Check the plug and the cable before each use and have them replaced by a specialist if they are damaged.
- The charger is intended only for the batteries supplied with the strapping system. Do not charge any batteries from other manufacturers, use original spare parts only.
- Protect the charger and Li-ion battery against moisture; operate them in dry rooms only.
- Do not open the Li-ion battery and protect it from shock, heat and fire. Danger of explosion!
- Store batteries in a dry frost-proof place. The ambient temperature must not exceed 122°F and must not fall below 23°F.
- Damaged batteries may not be reused and must be disposed of properly.



Note!

- Keep the connection plug of the charger and the ErgoStrap system away from non-related objects and dirt.

3.1.1 General safety instructions for Li-ion batteries

- Remove the battery from the strapping system before transporting or storing it. There is a risk of injury if the system is activated unintentionally.
- Only operate the battery and accessories when they are in perfect condition.
- Do not use a defective or damaged battery.
- Only use batteries that are approved for your systems (original ErgoStrap battery).
- Persons with reduced physical, sensory or mental capabilities or lack of experience and knowledge must not use the battery and charger unless they are supervised or instructed to do so by a person responsible for their safety.
- Do not short-circuit the battery.
- Do not subject the battery to mechanical shocks.
- Do not open or disassemble the battery.
- Avoid large temperature changes.
- Protect the battery from heat above 140 °F and fire. Excessive temperatures can cause liquid to leak from the battery and damage the battery casing. Avoid contact with the liquid.
- Do not immerse the battery in liquids.
- Do not use the battery with a defective connection cable or defective contacts.
- For disposal of the battery, see chapter 2.6.

3.1.2 General safety instructions Charger

- Check the charger housing, cables and plugs for damage (e.g. cracks, changes to the metal surfaces on the plugs or deformation) before using it. Do not use the charger if it is damaged.
- Only connect the charger to suitable mains sockets.
- Do not open the charger, reach inside the charger with tools or insert anything into the charger.

3.1.3 Safety instructions for charging

- Read the instructions for the charger before charging.
- Operate the charger only in enclosed spaces that are ventilated, dry and dust-free. Do not cover the unit.
- Make sure that the charging current and voltage are suitable for your battery. You will find this information on the type plates or in the documentation supplied.
- Charge the battery before use.
- Only charge Li-ion batteries. Do not charge lead-acid, NiCd, NiMh or non-rechargeable batteries.
- Supervise the battery and charger during a charge.
- Do not charge overheated batteries. Stop charging if the battery becomes too hot (> 140°F). The battery must be cooled down to ambient temperature before charging. If there is a smell or smoke or if the battery is too hot to touch, stop charging immediately and contact the battery manufacturer.
- After charging is complete, disconnect the mains plug and the charging plug.

3.1.4 Safety instructions for cleaning the battery and charger

- Keep the battery and contacts clean and dry. Clean dirty contacts with a dry cloth.
- Do not clean the battery with solvents (i.e. thinner, alcohol, oil, corrosion protection) or cleaning agents.
- Do not clean the battery with a water jet, high-pressure cleaner or steam cleaner.
- Keep the charger clean and dry. Disconnect all plugs before cleaning the charger. Clean the charger with a dry or at most damp cloth.

3.1.5 Safety instructions for storing the Li-ion battery pack

- Remove the battery from the strapping system or disconnect it from the charger when not in use.
- Store the battery in a dry, well-ventilated place away from flames and food.
- Do not store the battery near heating appliances and protect it from direct sunlight.
- Do not store the battery near hot or flammable objects. There is a risk of explosion.
- Keep small metal objects away from the battery. Danger of short circuit.
- Temperature: -4,0 to 140 °F

3.1.6 Safety instructions for implant users

- For technical reasons, electromagnetic (non-ionising) radiation is generated at the electrical cables. Implant carriers must not be in the direct vicinity of the radiation.

4. Description

4.1 Design



Fig. 4



Fig. 5

- Control panel
- Safety cutter
- Strap brake
- Control display



Fig. 6



Fig. 7

- Sealing head
- Sliding window with safety switch
- Operating instructions
- Tool-Lift
- Covering of battery box

4.2 Control panel strapping system

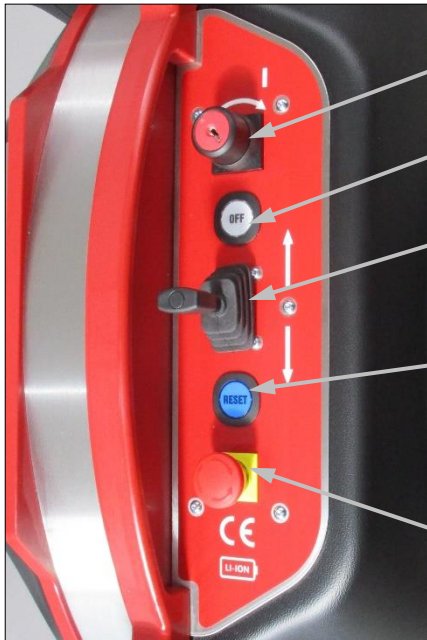

Main switch (power supply 0/1)

OFF switch (disconnects the power supply)

Joystick (moving the ChainLance in and out with precision speed control)

Reset switch (function check while switching on and acknowledging of malfunctions)

EMERGENCY STOP switch (stops the strapping system)

Fig. 8

4.3 Touch display strapping system



Fig. 9

Touch display for setting all parameters at the strapping system, such as pallet width.

Function key F1 – F4:

- F2 Strap coil changing mode
- F3 Menu

4.4 Control panel sealing head

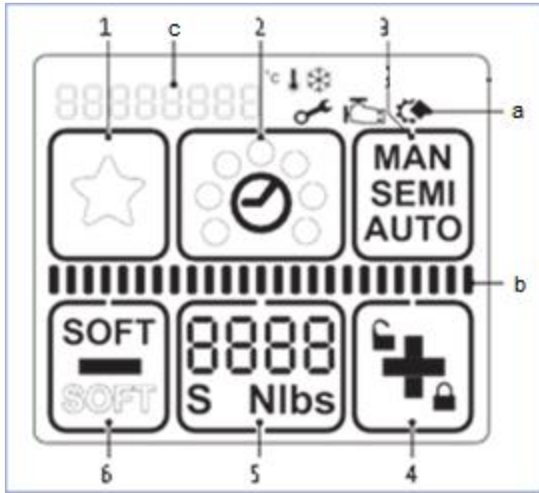

Fig. 10

- 1 „Favourite“
- 2 „Welding time“
- 3 „Operating mode“
- 4 „Plus & Keylock“
- 5 „Tension force“
- 6 „Minus & Soft tension“
- a „Information symbols“
- b Status indicator bar
- „Tensioning/Welding“
- c Display „Messages“



Display activated.



Welding process is finished, tool can be removed.

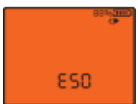

Application error: Temporary system error, can be rectified by the operator.



Tool fault: static system error, rectify error. If the error cannot be rectified -> ErgoStrap service partner

4.5 Li-ion battery

4.5.1 General view Li-ion battery

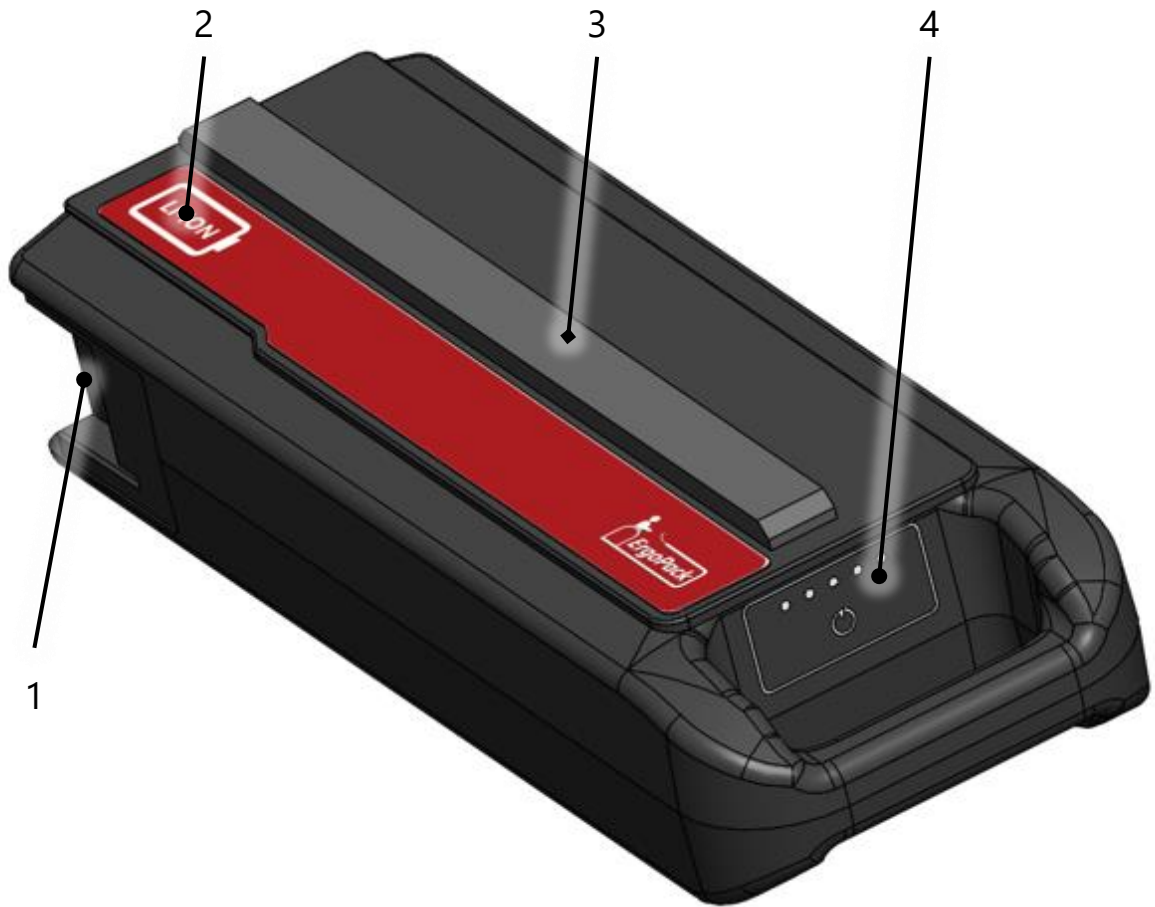

Fig. 11

1. "Charge and discharge socket"
2. "Sticker"
3. "Anti-twist device"
4. "Charge status LED display with on/off button"

4.5.2 LED display Li-ion battery

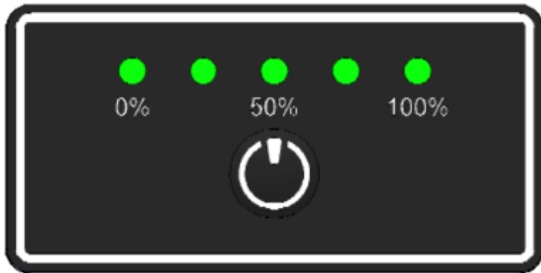

Fig. 12

Charging status LED display
(Display after pressing the on/off button.)

LED 1, 2, 3, 4, 5	State of charge
●●●●●	100...84%
●●●●○	83...68%
●●●○○	67...51%
●●○○○	50...34%
●○○○○	33...16%
★○○○○	15...0% Recharge after two days at the latest to avoid permanent damage.
★★★★★	Battery defective. Please contact your ErgoStrap service partner.

Explanation of symbols LED display

Symbol	Meaning
●	LED on
○	LED off
★	LED flashes (50% on, 50% off)

4.6 Indication and commissioning of the Li-ion Battery charging Station/Charger

4.6.1 General view of the Li-ion battery charging station

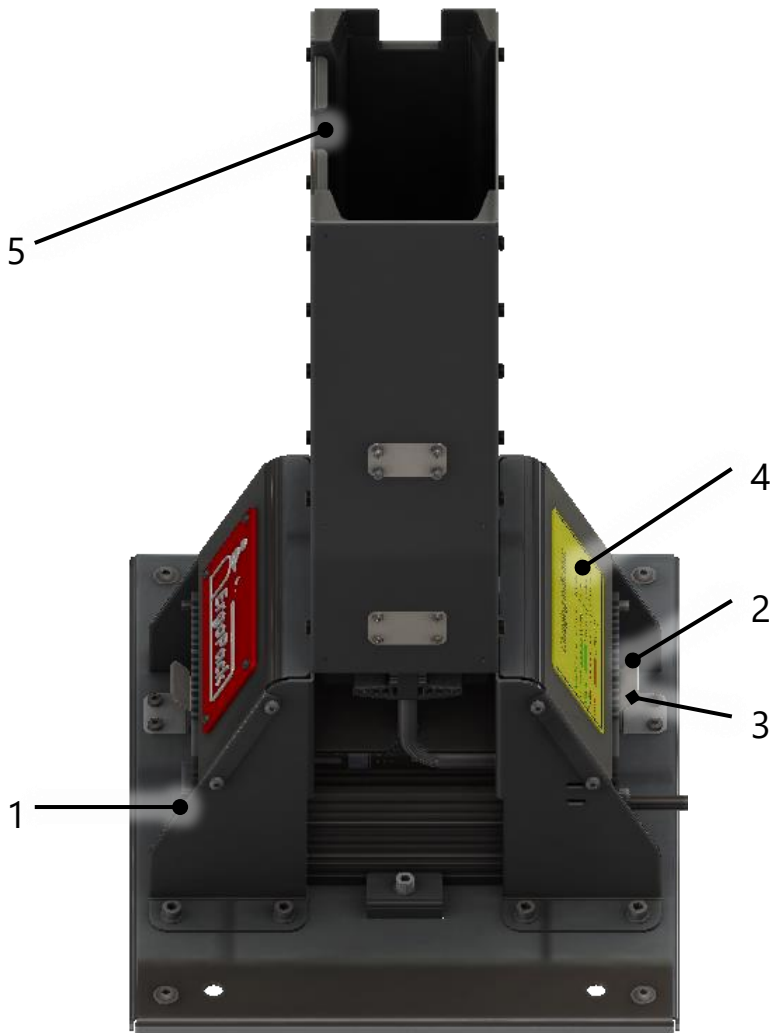

Fig. 13

1. Mains switch
2. LED-Green
3. LED-Red
4. Overview charge level indicator
5. Channel for anti-twist Li-ion battery

4.6.2 General view of Li-ion battery charger



Fig. 14

1. Mains switch
2. LED-Green
3. LED-Red
4. Overview charge level indicator





4.6.3 Commissioning the Li-ion Battery Charging Station/Charger

The ErgoStrap Li-ion charging station/charger is used to charge the ErgoStrap Li-ion battery is charged.

The green or red LED display on the Li-ion charger shows various operating states of the charger and the charge status of the Li-ion battery.

- 1) Plug the mains cable into the Li-ion charger and the mains socket as far as it will go.
- 2a) Carefully insert the Li-ion battery into the Li-ion charging station (do not let the battery fall into the shaft)!
- 2b) Insert the charging cable into the charging socket of the Li-ion battery as far as it will go.
- 3) Switch on the mains switch on the charger.
⇒ The charging process begins.
- 4) As soon as the battery is fully charged, the charger automatically ends the charging process.
⇒ The LED lights up green.
- 5) Before removing the charged Li-ion battery, switch off the mains switch on the charger.

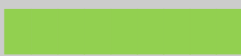
Explanation of symbols LED display

LED	Status
 green	Ready
 green	Battery charges
 green	Battery full
 red	Battery fault
 red	Charger malfunction
off	Not in operation

5. Technical data

5.1 Strapping system

Dimensions (all types)

Length	26"
Width	30"
Height	47"

Weight (without optional equipment):

ErgoStrap 700X-Li (incl. Li-ion battery)	210 lbs
ErgoStrap 713X-Li (incl. Li-ion battery)	227 lbs
ErgoStrap 726X-Li/745X-Li (incl. Li-ion battery)	229 lbs

Maximum chain speeds:

Slow, strapping

Moving out horizontally:	1063"/min
Moving out vertically:	2087"/min
Moving in vertically:	2047"/min
Moving in horizontally:	1535"/min

Medium, strapping

Moving out horizontally:	1142"/min
Moving out vertically:	2283"/min
Moving in vertically:	2244"/min
Moving in horizontally:	1772"/min

Fast, strapping

Moving out horizontally:	2598"/min
Moving out vertically:	3071"/min
Moving in vertically:	2992"/min
Moving in horizontally:	2559"/min

Strap changing: setting up/threading in strap

Moving out:	394"/min
Moving in:	315"/min

Max. Chain thrust:	70 lbf
--------------------	--------

Plastic strap

Strap materials	Polypropylene (PP) Polyester (PET)
Strap width	
713X, adjustable to	3/8" - 1/2"
726X, adjustable to	1/2" - 5/8"
745X, adjustable to	5/8" - 3/4"
Strap thickness	
713X	0,015" - 0,031" (PET) 0,019" - 0,031" (PP)
726X	0,019" - 0,040" (PET/PP)
745X	0,031" - 0,051" (PET/PP)

5.2 Sealing head

Weight: 8,4 - 9,5 lbs*
(incl. spiral cable)

Dimensions length 13,2"
(incl. spiral cable) width 5,5"
height 7,1"

Tension
713X 90 - 270 lbf
726X 200 - 560 lbf
745X 290 - 1000 lbf

Tensioning speed 11 1/2" /s (713X)
8 1/2" /s (726X)
4 3/4" /s (745X)

Sealing friction-weld sealing

*depending on the type used

Measured A-graded

noise emission level

(EN ISO 11202)

(EN 60745-1/2:2009)

713X	L _{pA}	79 dB (A)	L _{pAeq}	77 dB (A)
726X	L _{pA}	78 dB (A)	L _{pAeq}	82 dB (A)
745X	L _{pA}	79 dB (A)	L _{pAeq}	81 dB (A)

Sound power level, on average

(EN 60745 -1/2:2009)

713X	LW ^{Aeq}	88 dB (A)
726X	LW ^{Aeq}	93 dB (A)
745X	LW ^{Aeq}	92 dB (A)

Measurement inaccuracy K

713X	3,0 dB (A)
726X	3,0 dB (A)
745X	3,0 dB (A)

Hand arm vibrations without using a Tool-lift

(EN 60745-1/2:2009)

713X	a 2,4 ms ⁻²
726X	a 2,4 ms ⁻²
745X	a 2,3 ms ⁻²

Measurement inaccuracy K

713X	1,5 ms ⁻²
726X	1,5 ms ⁻²
745X	1,5 ms ⁻²

5.3 Li-ion battery

Typ:	Li-ion batteries
Weight:	approx. 11 lbs
Dimensions:	Length 15,5" Width 6" Height 3,3"
Cell interconnection:	10S7P
Voltage (nominal):	36,3 V
Capacity (nominal):	24,15 Ah
Energy:	877 Wh
Discharge current (nominal):	≤ 35 A
Charging current (max.):	14 A
Charging end voltage:	42 V
Operating temperature:	32...104°F

5.4 Li-ion battery – charging station/charger

Typ:	Wide range charger
Weight: Charger (incl. charging station)	3,75 lbs (19,4 lbs)
Dimensions:	Length 8,9" Width 2" Height 2,7"
Operating voltage:	100...240V 50/60 Hz
Rated power consumption:	up to approx. 650 W
Charging current (nominal):	up to approx. 10 A
Final charging voltage:	≤58,8 V
Protecting class:	IP20
Operating temperature:	32...104°F

6. Intended use

The strapping system is designed for strapping pallets (machine assisted hand strapping). It has been designed and built for safe and ergonomic operation during strapping.

The strapping system is only suitable for strapping with plastic straps (polypropylene PP and polyester PET). Strapping with steel strapping is not possible with this strapping system.

The strapping system is not designed for strapping open and unpacked food products.

Strapping of flammable products (highly flammable, explosive see table of hazardous substances) is only possible in suitable outer packaging.

The set tension force must correspond to the packaged goods to be strapped. Constructing the strapping system there was not considered any risk due to damaging of dangerous products or their package.

The strapping system is not designed for strapping in areas with explosive atmospheres (ATEX areas).

Strapping generates electrostatic charges. These can be reduced by a relative humidity of more than 45% and by a conductive or electrostatically dissipative floor (dissipation resistance less than $10^9 \Omega$).

The strapping system is not suitable for operation by persons with implants such as pacemakers or defibrillators.

7. Commissioning



Attention!

Before using the strapping system for the first time, a visual inspection for exterior damages has to be done.

7.1 Li-ion battery-charging station/charger

The main voltage must comply with the details on the type plate.
The Li-ion battery charging station / charger is only suitable for charging the supplied original ErgoStrap Li-ion battery, article number EP103110.

7.2 Charging the Li-ion battery

- 1.) Connect charger to the main voltage
- 2.) Open cover of Li-ion battery case (by pulling at the outer corners as shown below).



Fig. 15

3.) Remove the Li-ion battery from the strapping system by pulling it out.

4a.) When using the Li-ion Charging station, the Li-ion Battery into the Li-ion charging Station to load up to the stop gently into place. Then close Power switch on the Li-ion Set the charger to "I".

4b.) When charging without a Li-ion charging station, insert the charging cable the charging cable into the socket of the Li-ion battery. Then press the mains switch on the Li-ion charger to "I".

5.) Before removing the charged Li-ion battery, switch off the mains switch on the charger.

6.) Carefully insert the charged Li-ion battery into the battery compartment as far as the into the battery compartment as far as it will go.

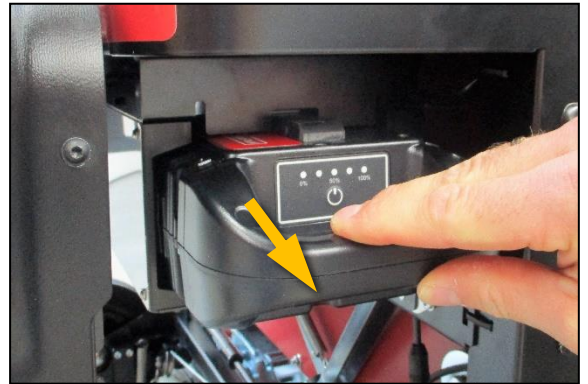

Fig. 16



Fig. 17



Fig. 18



Fig. 19



Attention!

When inserting the Li-ion battery into the strapping system, the anti-twist device must point upwards!



Warning!

Damaged Li-ion batteries can burn or explode.

- ▶ Never use dropped or damaged Li-ion batteries.
- ▶ Store dropped Li-ion batteries in a non-flammable container.
- ▶ Send dropped Li-ion batteries to your ErgoStrap service partner. For shipping, see chapter 2.7.



Attention!

The charging time is approx. 3 hours. The Li-ion battery is only fully charged when all 5 LEDs on the Li-ion battery light up green continuously!

The Li-ion battery and the Li-ion charger should be supervised during the charging process.

Do not charge an overheated Li-ion battery. The charging process must be interrupted if the Li-ion battery heats up too much ($> 140^{\circ}\text{F}$). The Li-ion battery must be cooled down to ambient temperature before further charging. If there is a smell or smoke or if the Li-ion battery is too hot to touch, the charging process must be interrupted immediately and the ErgoStrap service partner informed.



Note!

If the Li-ion battery is stored (not used) for a longer period of time, this should be done with a charge level of approx. 50% and, if necessary, recharged approx. every 3 months.

7.3 Setting strap width at the sealing head

The sealing head can be used with different strap widths:

ErgoStrap 713X	3/8" or 1/2"
ErgoStrap 726X	1/2" or 5/8"
ErgoStrap 745X	5/8" or 3/4"

The setting of the strap width is explained using the example of model 726X. The setting of the strap width with the models 713X from 3/8" to 1/2" and 745X from 5/8" to 3/4" works accordingly.

a) Change strap width from 1/2" to 5/8"

- Switch the strapping system off
- Release three cylinder screws Torx (6). Lift the rocker lever towards the handle, release cylinder screw Torx (7) and remove strap guide rear 1/2" (8).
- Remove side cover (5).
- Release counter-sunk screw Torx (2) and remove strap guide front 1/2" (1).
- Release counter-sunk screw Torx (4) and remove strap guide front 1/2" (3).
- Release cylinder screw Torx (10) and remove strap guide rear 1/2" (9).
- Fit side cover (5) (secure cylinder screw with screw locking varnish "medium-tight". Install strap guide rear 5/8" (8).

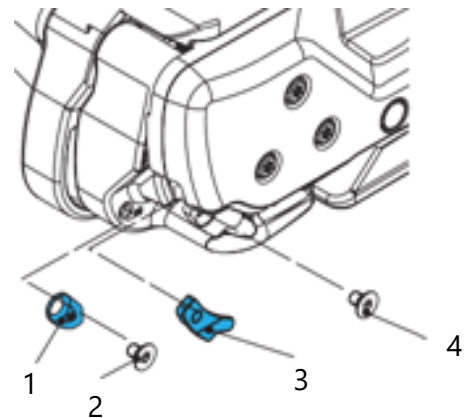

Fig. 20

b) Change strap width from 5/8" to 1/2"

- Switch the strapping system off
- Release three cylinder screws Torx (6). Lift the rocker lever towards the handle, release cylinder screw Torx (7) and remove trap guide rear 5/8" (8).
- Remove side cover (5).
- Fit strap guide front 1/2" (1) (secure counter-sunk screw with screw locking varnish "medium-tight").
- Fit strap guide front 1/2" (3) (secure counter-sunk screw with screw locking varnish "medium-tight").
- Fit strap guide rear 1/2" (9) (secure cylinder screw with screw locking varnish "medium-tight").
- Fit side cover (5) (secure cylinder screw with screw locking varnish "medium-tight"). Install strap guide rear 1/2" (8).

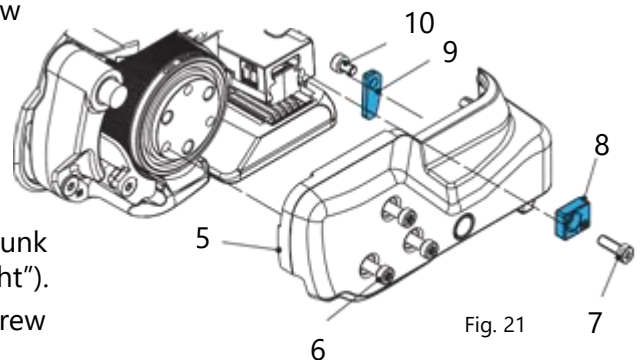

Fig. 21

7.4 Switching on the strapping system

Instructions:

- Charge the Li-ion battery pack as described under 7.2.
- Carefully push the Li-ion battery into the battery compartment of the strapping system as far as it will go. Observe the installation position of the anti-twist device.
- Close the cover of the Li-ion battery case.
- Make sure that the EMERGENCY STOP switch (23a) is not pressed. If necessary, unlock it by turning.
- Turn the main switch (23d) to the right to operating mode “1” and hold it in this position for approximately 2 seconds.



Fig. 22



Fig. 23

23a

23b

23c

23d

- Follow the instructions on the display after the “ErgoStrap” logo disappeared (after approx. 45 seconds).

7.5 Setting the date and time



Attention!

The date and time may only be set by trained, instructed personnel. You can obtain the required access code from your ErgoStrap service partner.

1. Step:

Check the time in the display in the main menu at the top left.

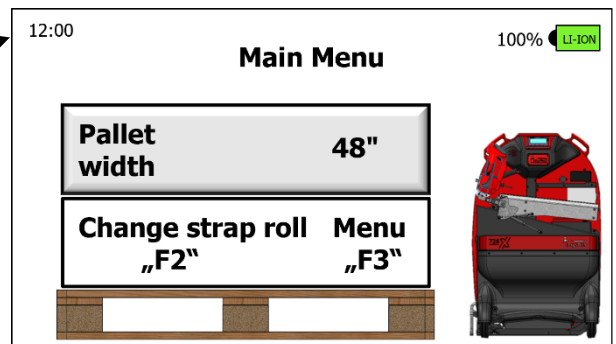

Fig. 24

2. Step:

Press the "F3" button (1) on the display and press repeatedly on "Next" (2) until menu page 8 (3) appears.

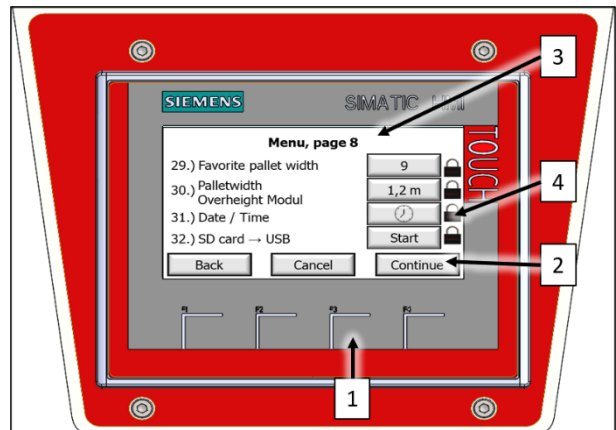

Fig. 25

3. Step:

Press the "Clock" button (4) in menu line "31.)".

4. Step:

Unlock the lock with the corresponding access code.

5. Step:

Check the date.

Year, month and day can each be set with the "+/-" button.

Then confirm the set date with the "Store" button.

If the date does not need to be set, you can switch to setting the time by pressing the "Store" button.

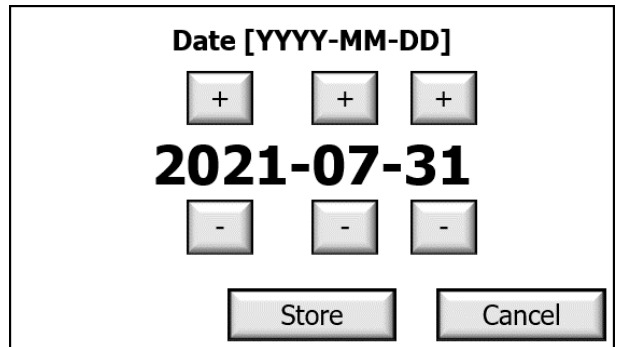

Fig. 26

6. Step:

Check the time.

Hour and minute can each be set with the "+/-" button.

Then confirm the time with the "Store" button.

If the time does not need to be set, the date/time setting can be saved by pressing the "Store" button.

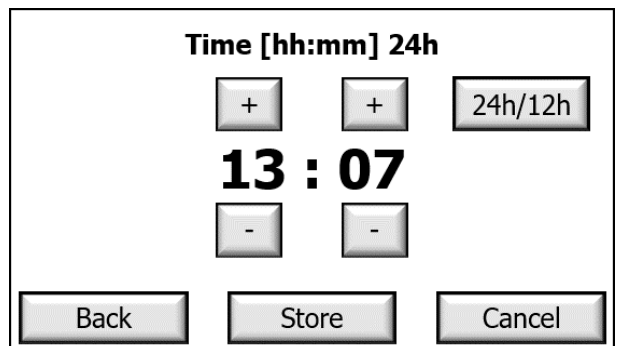

Fig. 27

Press the "24h/12h" button to switch between 24-hour or 12-hour format.

7.6 Setting strap tension range at the sealing head

Two strap tension ranges can be set at the sealing head:

NORMAL = Standard tension range for PET strap

713X = 90 - 270 lbf

726X = 200 - 560 lbf

745X = 290 - 1000 lbf

SOFT = Soft tension range for PP strap

713X = 33 - 165 lbf

726X = 90 - 305 lbf

745X = 90 - 360 lbf

Press „Soft“ button (a).

The soft mode **is deactivated** when the „SOFT“ display (b) changes position and is shown outlined.



Press „Soft“ button (a).

The soft mode **is activated** when the „SOFT“ display (c) changes position and is shown in bold.

The displayed tension force is reduced correspondingly.

On the left under the tension force an "S" (d) also appears.

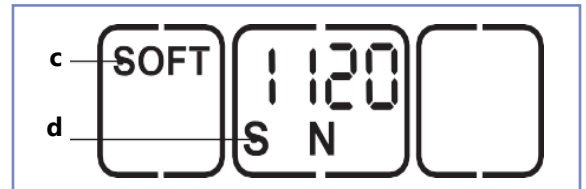

Fig. 28



Attention!

Always use the SOFT tension mode when working with PP-strap!

By using the Soft mode, the tension wheel accelerates more slowly and avoids excessive strap waste when sealing with PP strap.

7.7 Setting strap tension at the sealing head

The set tension force is displayed continuously when the tool is ready for operation.

- Press „tension force” button (2).
 - The set tension force flashes for 5 seconds.
 - The buttons + (1) and – (3) appear.
 - Unused displays disappear.
- Press + (1) or – (3) button until the required tension force is displayed.
 - The status indicator bar (4) shows the set tension force in relation to the possible maximum value.
- Save: Press „tension force” button (2) or wait for 5 seconds.

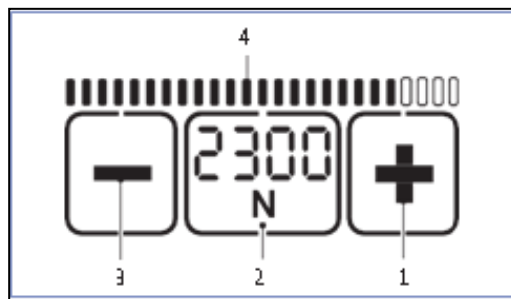

Fig. 29



Note!

- Switch between display in „N” or „lbf”: Press the flashing „tension force” button (2) for two seconds.
- Every time the button is pressed an acoustic signal confirms the action.
- The tension force is displayed continuously when the tool is operational.
- Setting soft tension (section 7.6).

713X										
Standard	N*	400	500	600	700	800	900	1000	1100	1200
	lbf*	90	110	135	155	180	200	225	250	270
Soft	N	150	225	300	375	450	525	600	675	750
	lbf	33	50	67	85	100	120	135	150	165

726X										
Standard	N*	900	1100	1300	1500	1700	1900	2100	2300	2500
	lbf*	200	250	290	340	380	430	470	520	560
Soft	N	400	520	640	760	880	1000	1120	1240	1360
	lbf	90	115	145	170	200	225	250	280	305

745X										
Standard	N*	1300	1700	2100	2500	2900	3300	3700	4100	4500
	lbf*	290	380	470	560	650	740	830	920	1000
Soft	N	400	550	700	850	1000	1150	1300	1450	1600
	lbf	90	120	160	190	225	260	290	325	360

(rounded values)

* N = Newton, lbf = pound-force per square inch



Warning!

Adjusted tension force must relate to the packaged goods to be strapped.

Possible hazards caused by damages of dangerous goods or their packaging are not considered with the design of the strapping system.

7.8 Setting mode of operation at the sealing head

Press „Operating mode“ (1) button.

- Unused displays disappear.
- The currently set operating mode flashes for 5 seconds.
- + and – appear.

Press button + (2) or – (3) until the required operating mode is displayed.

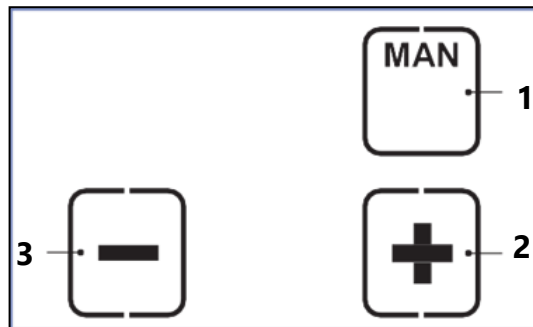

Fig. 30

MAN/ SEMI/ AUTO

By pressing the „Operating mode“ button (1) again, or after waiting 5 seconds, the set mode is saved. Each operating mode can also be selected for the tension range „Soft tension“ (Section 7.6).

- **MAN = Manual**

The tensioning button must be pulled and held until the desired strap tension has been reached. The welding button must then be briefly pressed so that the straps are welded and the upper strap is cut off.

- **SEMI = Semi-automatic strapping (standard/factory setting)**

The tensioning button must be pulled and held until the set tension force has been reached. The straps are then automatically welded and the upper strap is cut off. It can be welded manually at any time by pressing the welding button.

- **AUTO = Fully automatic strapping***

The tensioning button has to be pulled (touched) once only. This triggers the tensioning process. Once the set tension force has been reached, the straps are automatically welded and the upper strap is cut off.

* This operating mode AUTO = Fully automatic strapping is factory blocked! Activation only through your ErgoStrap service partner possible.



Warning!

Strap tensioning or strapping, danger of jamming and crushing

Do not place hands or other body parts between the strap and the packaged goods during the strapping process. Ensure that there are no other persons in the hazard zone.

For an emergency stop in the case of danger (trapped person):

To release the strap tension (before welding), pull the rocker lever. In operating mode AUTO, also the tensioning or welding button can be pressed again. After welding, cut the strap using a tool (strap cutter).

7.9 Select favourite*

The function „favourite“ activates a second settings level, whose parameters can be set freely like those of the main level.

This enables the operator to quickly change from one setting into the other.

Deactivate favourite:

- Press „favourite“ button (1). The star (2) changes from bold to outlined. All parameters change to the pre-set values of this settings level.

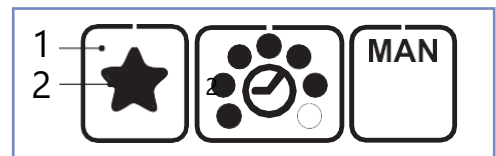

Fig. 30 a

Activate favourite:

- Press „favourite“ button (1). The star (3) changes from outlined to bold. All parameters change to the pre-set values of this settings level.

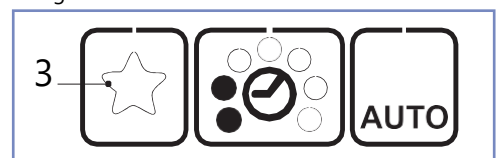

Fig. 30 b

* The operating mode favourite is factory blocked! Activation only through your ErgoStrap service partner possible.

7.10 Setting welding time

The set welding time is displayed always by filled dots, when the system is ready for operation.

- Press „welding time“ button (2).
 - Unused displays disappear.
 - The filled dots of the current set welding time flash for 5 seconds.
 - + and – appear.
- Press button + (1) or – (3) until the required welding time appears.
- Save: Press „welding time“ button (2) or wait for 5 seconds.

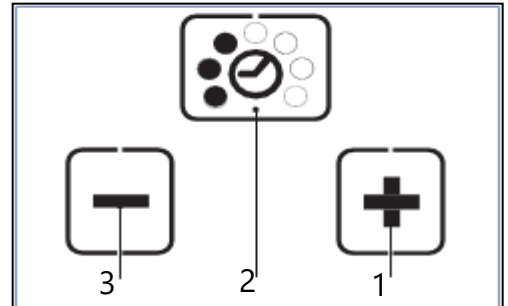

Fig. 31

7.11 Changing strap coil

Switch on the strapping system as described in section 7.4

For changing the strap coil press „F2” button (32a) and follow the instructions appearing on the display.



Fig. 32

32a

By pressing „next” button, **1. Step** appears on the display.

1. Step

By pressing the „Positioning ChainLance” button, the ChainLance will automatically reach the correct position so that the red chain link stops in the middle of the sliding window.

For this process the sliding window must be closed!

Once the ChainLance reached the right position, the **2. Step** appears automatically.



Note!

By pressing the „Stop” button the strap coil changing mode can be stopped at any time and you will get back to the main menu.

2. Step

Open the sliding window (33a).
After opening the sliding window, **3. Step** appears automatically.

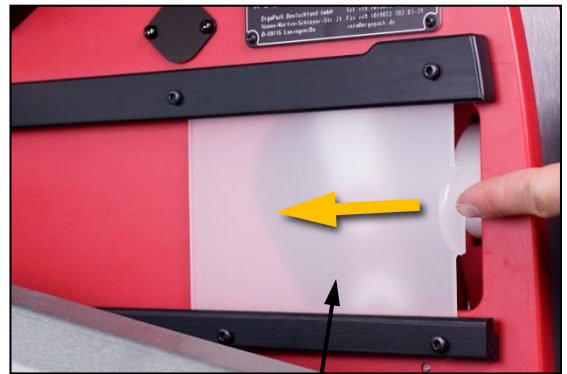

Fig. 33

33a

3. Step

Fold down the pivot arm with the red circular disk until its final stop.



Fig. 34

Place a new strap coil onto the red circular disk, that the strap uncoils in the **counter-clockwise direction** when looking down on the roll.



Fig. 35



Note!

Do not yet remove the tape or adhesive tape, which fix the strap on the coil!

Fold up the arm with the strap coil again in its vertical position as shown on the picture.



Fig. 36

Now, remove the tapes or adhesive tapes fixing the strap on the coil.



Fig. 37



Attention!

Remove adhesive tapes from the strap coil **completely**. Adhesive residues remaining on the strap coil may stick inside the strapping system and lead to malfunctions.

Fold up the cover of the white roll for strap infeed, thread the strap through the U-bolt...



Fig. 38

...and over the white roll to the inside. Thereafter fold the cover back down again.



Fig. 39



Fig. 40

After pressing „Next“ on the touch display you will finish the 3. Step and get to the **4. Step.**



Fig. 41

4. Step

Press from the left hand side on the metal clamp lock located in the red chain link...



Fig. 42

...then slide the strap from the right to the left through the slot in the clamp lock.



Fig. 43



Fig. 44

To finish the 4. Step, the sliding window has to be closed.



Fig. 45

5. Step

Press the „Positioning ChainLance“ button until the ChainLance stops automatically and the **6. Step** appears.



Fig. 46



Fig. 47



Warning, risk of injury!

Never put your fingers between the chain links.



6. Step

Remove the strap from the clamp lock of the red chain link and hold it straight up as shown (Fig. 50).

Thereafter, press the „Retract chain“ button until the ChainLance stops and the **7. Step** appears.



Fig. 48



Fig. 50



Fig. 49



Warning, risk of injury!

Never put your fingers between the chain links.



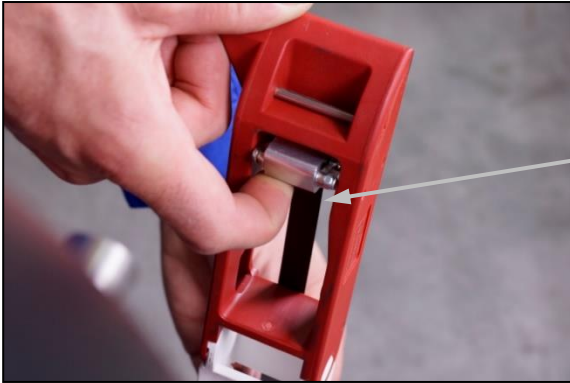

Fig. 51

7. Step

Open the eccentric latch in the red head piece of the ChainLance by pushing it inwards with your finger. (Fig. 51)



Fig. 52

Push the strap from the back through the head piece of the ChainLance (as shown).

The strap must pass between the two aluminium eccentrics.



Warning, risk of injury!

Never put your fingers between the chain links.





Fig. 53

Move the reversing sledge completely backwards by pressing the „Retract ChainLance“ button. Afterwards you will get back to the **main menu**.



Attention!

Make sure that the strap remains continuously tensioned while moving back the ChainLance, to avoid the strap being pushed into the strapping system.



Fig. 54

Place the overlapping strap with a loop through the small slot underneath the left handle (as shown).

7.12 Setting pallet width

1. Step:

To set the correct pallet width, press the „Pallet width“ button in the main menu.

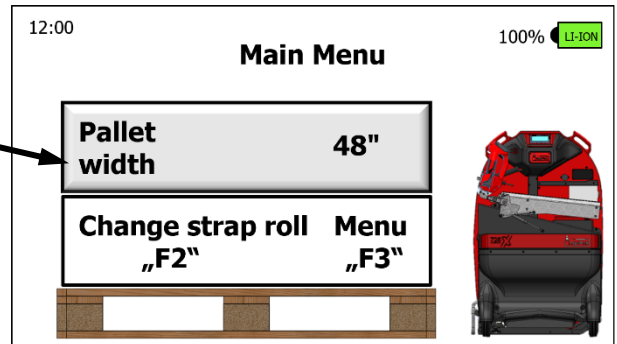

Fig. 55

2. Step:

You can choose the required width of the pallet to be strapped among the factory set pallet widths.

In case the required pallet width is not listed, you can adjust one of these buttons to the required pallet width.

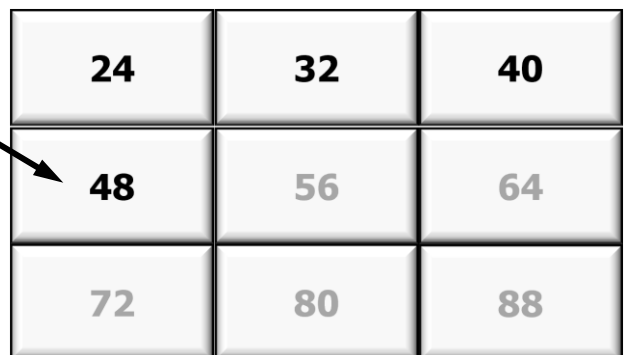

Fig. 56

For changing one of the buttons to the required pallet width, proceed as follows:

Press and hold the button to be changed for approx. 3 seconds. You can then set the required pallet width in 10 cm steps (Fig. 57). As soon as you confirm your setting with „OK“, this new pallet width will be saved in the preset pallet widths.

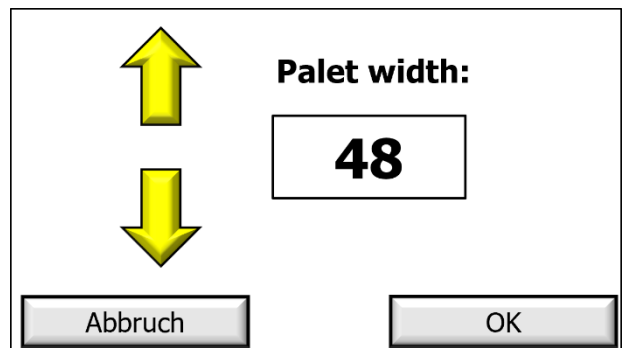

Fig. 57

Your ErgoStrap is now ready for strapping.

8. Operation

8.1 Strapping



Fig. 58

1. Step

Place the ErgoStrap at a distance of approx. 12" (D) in front of the pallet to be strapped.

If your system is equipped with the optional line laser:

Align the ErgoStrap parallel to the pallet so that the laser line runs alongside the pallet edge.



Fig. 59

2. Step

Move out the ChainLance by pushing the joystick in „move out“ direction.

The reversing sledge leads the strap through and underneath the pallet...



Fig. 60

... and back up again on the opposite side.



Fig. 61

If the setting of the pallet width and the positioning of the strapping system are correct, the distance between the chain and the pallet is about 4".



Attention!

Push the joystick until the ChainLance appears on the other side and falls in your direction.

Release the joystick, so that it returns to the neutral position (central position) and stops the ChainLance moving out further.

Catch the ChainLance as shown at the red head piece. Do not let the ChainLance drop onto the package!



3. Step

Hold the strap with your left hand as shown, **directly at the head piece of the ChainLance...**

Fig. 62



... move the ChainLance completely back by pushing the joystick in „move in“ direction.

Fig. 63



Attention!

Always keep the strap slightly under tension when moving the ChainLance backwards, to avoid that loops can be formed at the reversing sledge. Loops may lead to malfunctions while moving back the ChainLance.

4. Step

The strap lifter comes up automatically when the reversing sledge moves back into the strapping system.

Now you have to loose the strap tension of your left hand; otherwise the strap lifter will not be able to come up.

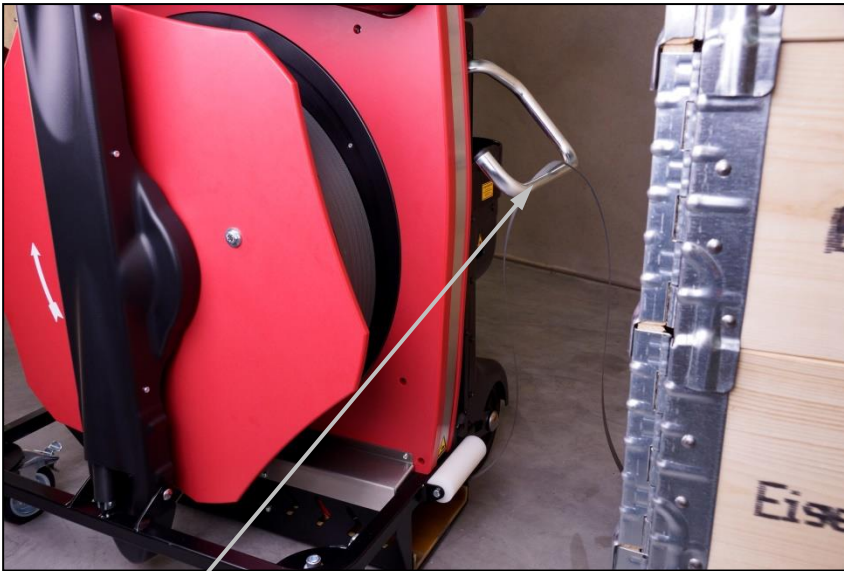

Fig. 64

The strap lifter lifts the second end of the strap up to working height so you can grasp it without bending down.

Only keep the joystick pushed until the strap lifter is fully in its upper position.

The time, how long the strap lifter should remain in its upper position, can be set in „page 3“ of the menu.



Attention!

You have to hold the strap loosely in your hand when the strap lifter comes up.

The strapping system automatically switches off to prevent damages if you do not let go of the strap when the strap lifter rises. The strap lifter can be raised up again by pushing the joystick in the „move in“ direction twice.



Fig. 65

If for sealing the strap you have to pull some additional strap out of the strapping system, do not take the strap directly at the strap lifter...

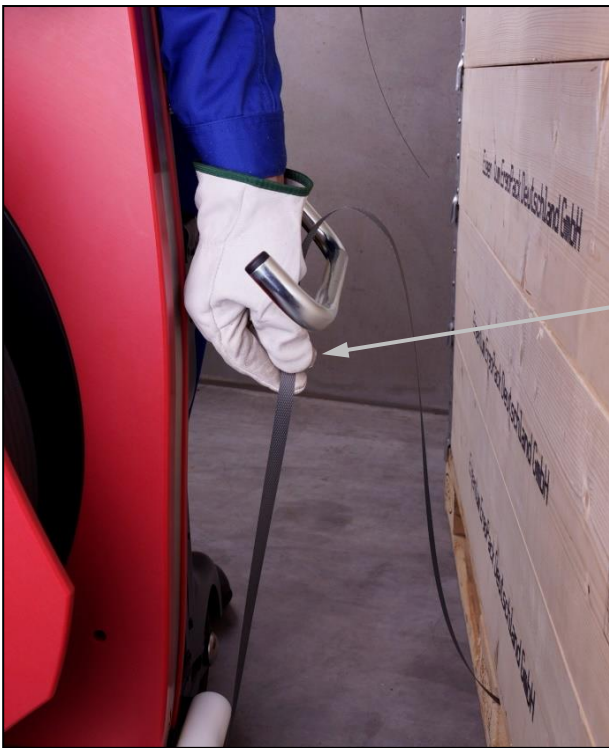

Fig. 66

...but about 4" below the strap lifter. Hold the strap with the whole hand and pull it out of the strapping system. At the same time, you have to let the end of the strap slide through your other hand!



Fig. 67

If your strapping system is equipped with the optional strap break relief:

Before pulling at the strap, press down the foot pedal at the left side. This reduces the brake force of the strap coil and eases pulling out strap a lot.

8.2 Tensioning and sealing of pallets heights over 27"

1. Step

Strap the pallet as described in section 8.1

2. Step

Overlap the straps so that the end of the strap lies underneath.

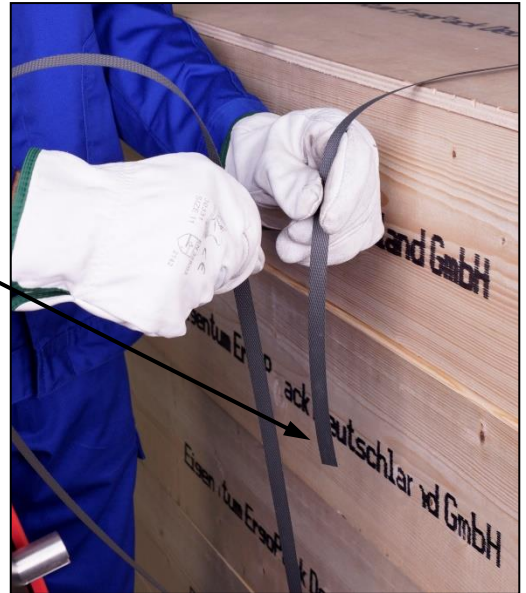

Fig. 68

3. Step

Hold then both straps as shown with the **right hand**.

The end of the strap should lie in your hand and not project beyond it!



Fig. 69

4. Step

Push the sealing head towards the pallet with the left hand and tilt it forward at the same time so that the sealing head is parallel to the package.

Pull the rocker lever to open the clamp of the sealing head.



Fig. 70

With your right hand you can now feed the strap from the top to the bottom through the slot in the sealing head (similar to a credit card).

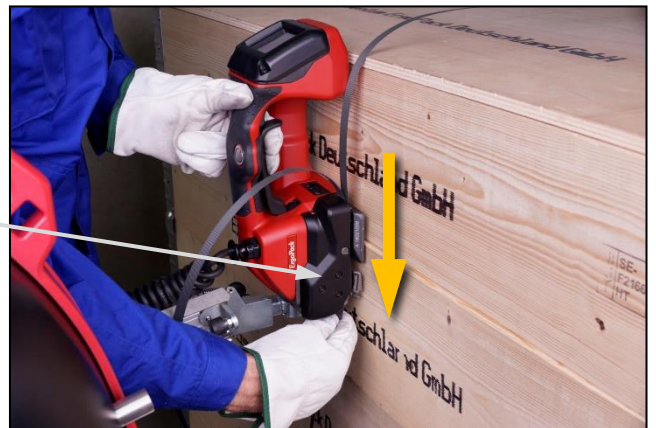

Fig. 71

Now let go of the rocker lever.

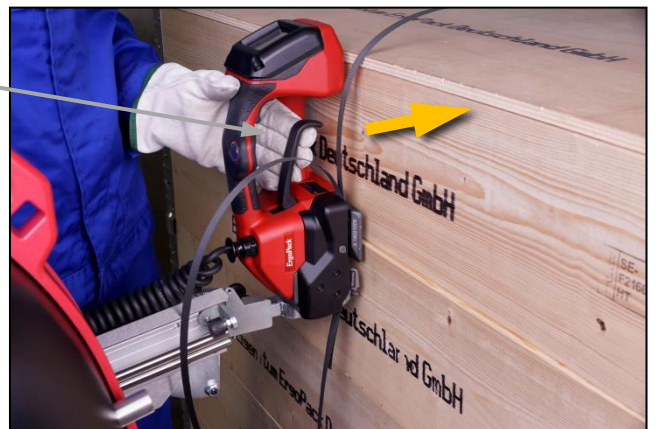

Fig. 72

5. Step

The tensioning and sealing of the strap is different according to the set mode (manual, semi-automatic or automatic mode) (see also section 7.8).

5.1 Manual tensioning and sealing

Pull the tensioning button (Fig. 73) until the required tension force is reached (see also section 7.7).

Thereafter, press the round welding button (Fig. 74) to weld both straps and to cut off the upper one.

5.2 SEMI-Semi-automatic tensioning and sealing

Pull the tensioning button (Fig. 73) until the pre-set tension force is reached. Afterwards, both straps will be automatically welded and the upper strap will be cut off. You can also weld the straps manually at any time by pressing the welding button even if the pre-set tension force was not reached.

5.3 Automatically tensioning and welding*

By a brief pulling (touching) of the tensioning button once, the sealing process (tensioning and welding) will be activated. Once the set tension force has been reached, the straps are automatically welded and the upper strap is cut off.

* This operating mode AUTO = Fully automatic strapping is factory blocked! Activation only through your ErgoStrap service partner possible.

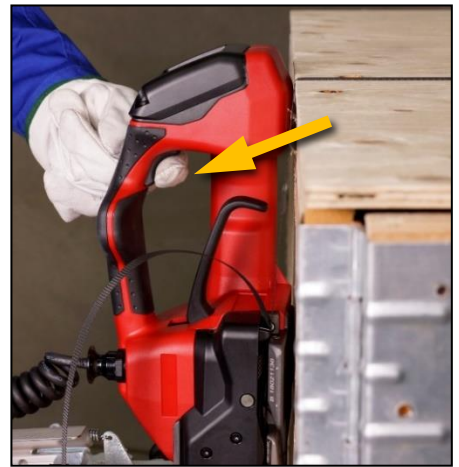

Fig. 73

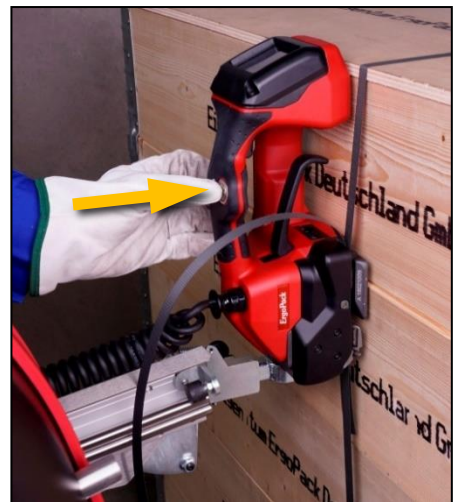

Fig. 74



Warning!

Strap tensioning or strapping, danger of jamming and crushing

Do not place hands or other body parts between the strap and the packaged goods during the strapping process. Ensure that there are no other persons in the hazard zone.

For an emergency stop in the case of danger (trapped person):

To release the strap tension (before welding), actuate the rocker lever, the tensioning or welding button. After welding, cut the strap using a tool (strap cutter).

The tensioning process is finished, once the indicator bar is filled in fully.

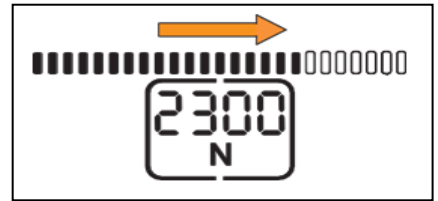

Fig. 75

The welding process is finished, once the indicator bar (1) is filled fully.

The cool down starts (2). After cool down there is a beep and the display lights up green.

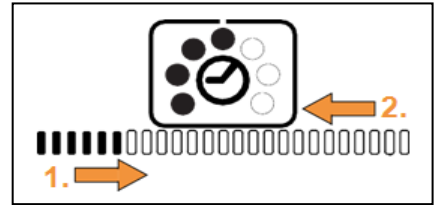

Fig. 76

6. Step

As soon as the countdown is finished and the signal has sounded you have to pull the rocker lever towards the handle.



Attention!

If after pressing the welding button, the welding process does not start, but the sealing head beeps, the tension button was not pressed first.

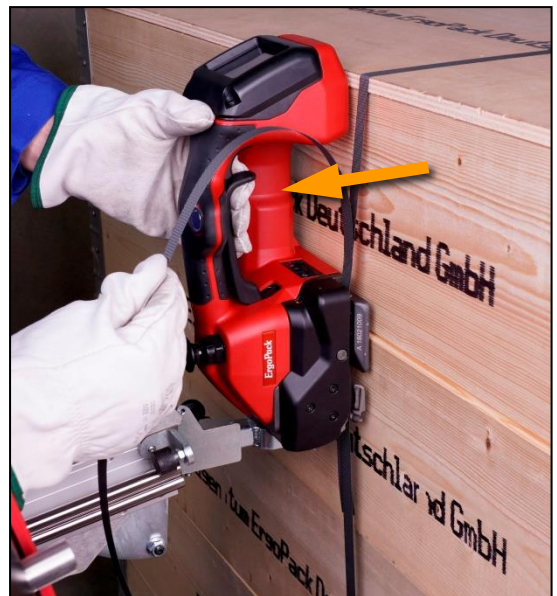

Fig. 77

7. Step

Now slew the sealing head to the left while keeping the rocker lever pulled.



Attention!

It is recommended to clean the sealing head regularly (at least daily), if there is a lot of strap waste. Especially the tension wheel and the tooth plate have to be checked for damages and kept clean. Please refer to section 10.10.

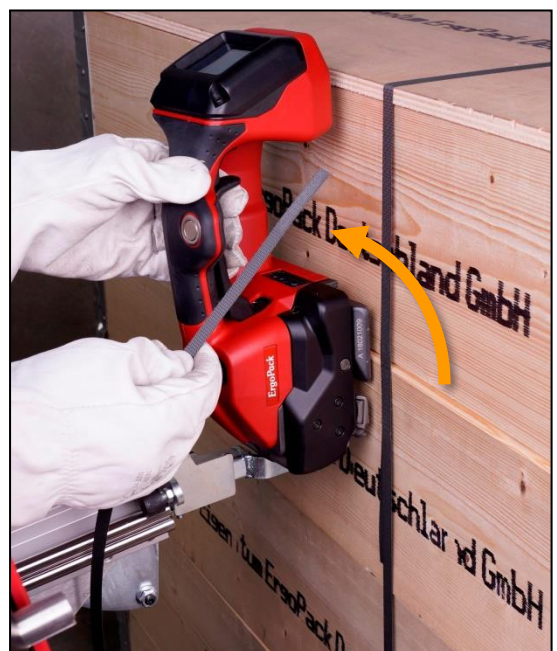

Fig. 78

8.3 Sealing control

Control the sealing regularly. The welding time must be checked in accordance with point 7.10 and changed if necessary when the straps are welded badly.

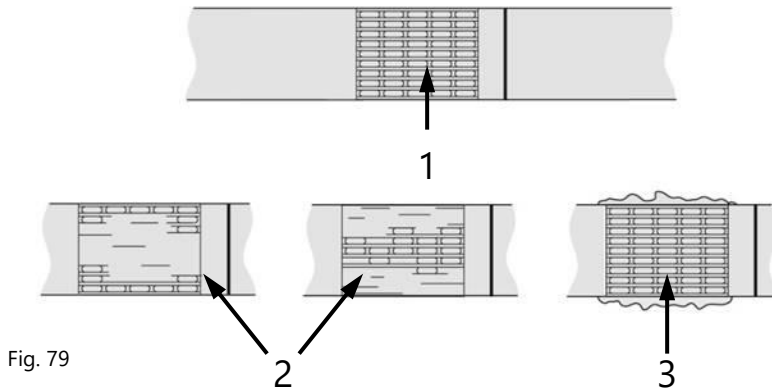

Fig. 79

1 Good welding: The whole sealed surface has been properly welded without any extra material being squeezed out to the side.

2 Bad welding: The surface has been unevenly welded, the selected welding time is too short.

3 Bad welding: Surplus material has been squeezed out to the side, the selected welding time is too long.



Warning!

Improper welded straps cannot secure the loads and can therefore cause injuries.

Never transport or move goods with improper welded straps.

8.4 Tensioning and sealing pallets below 27" height with ErgoStrap standard Tool-Lift



Fig. 80

1.Step

Pull out the black knob of the locking bolt. Afterwards, pull the sealing head forward out of the holder and place it on the package to be strapped.



Fig. 81

2. Step

Strap the package exactly as described under point 8.1.



Fig. 82

3. Step

Overlap both straps so that the beginning of the strap lies underneath.

Pull the rocker lever to open the clamp of the sealing head.



Fig. 83

Now, with your right hand, feed the strap through the guiding of the sealing head, by pulling it towards yourself.



Fig. 84

4. Step

The tensioning and the sealing of the strap is different according to the set mode (manual / semi-automatic or automatic mode, see point 7.8).



Fig. 85



Fig. 86

5. Step

As soon as the signal has sounded and the display lights up green, pull the rocker lever towards the handle and move the sealing head out to the left.



Fig. 87

If your strapping system is equipped with the optional Triplex Tool-Lift:

Pull out the sealing head horizontally, slew the sealing head by 90° into horizontal position and put it on top of the pallet.

Tensioning and sealing proceed exactly as described in the previous steps.

9. Risks



Attention: Laser beam!

Direct eye contact with the laser beam or reflecting radiation may result in permanent eye injuries.

Never look direct in the laser.

Laser category 2
DIN EN 60825-1:2015-07

Power: 10 mW
Wavelength: 635 nm



Warning:

Strap tensioning or strapping, danger of jamming and crushing.

Do not place hands or other body parts between the strap and the packaged goods during the strapping process.

Ensure that there are no other persons in the hazardous zone.

For an emergency stop in case of danger (trapped person):

- To release tension (before welding), open the rocker lever.
- After welding, cut the strap with a suitable tool (strap cutter)



Warning:

The following hazards can result in serious injury or death.

Explosion hazard in EX zones

The strapping system must not be used in areas where an explosive atmosphere may occur.

Risk of explosion or fire if Li-ion battery is damaged

Damaged batteries can burn or explode. Never use dropped or damaged batteries.

Electric shock

Strapping creates electrostatic charges. These can discharge via the user. The strapping system is therefore not suitable for operation by persons with implants such as pacemakers or defibrillators.



Warning!

Following hazards can result in serious injuries:

Chain lance, risk of injury

When the ChainLance moves upwards on the opposite side of the pallet, its own weight causes it to fall over the pallet towards the operator. **If you are not careful, the ChainLance can fall on the operator's head and cause injuries.** Always be alert and concentrated and catch the ChainLance if it falls over the pallet.

Incorrectly welded strapping cannot secure the load and can therefore lead to injuries.

Never transport or move a packaged good with an incorrectly executed weld.

Breaking strap, risk of injury

When being tensioned, the strap may break and rip. Do not stand in line with the strap and wear eye protection.

Strap ends snapping back, risk of injury

When cutting the strap, hold the upper portion and stand aside. Do not stand in line with the strap and wear eye protection.

ChainLance, risk of tripping

When parking the strapping system, the ChainLance must be fully inside it. The reversing sledge must not stick out.

Strap waste, risk of tripping

Make sure any strap waste or pieces of strap, which possibly appeared, will be removed from the floor quickly.

Sealing head and ChainLance, risk of crushing

Do not put your fingers into the area of the tension wheel of the sealing head and into the ChainLance.

Reversing sledge, risk of crushing

Especially around the entire surroundings of the reversing sledge, there is a risk of squeezing.



Warning!

Following hazards can result in serious injuries:

Hazardous area, risk of crushing and risk of injury

Make sure before each strapping cycle, that there is no person in the hazardous area (especially of the ChainLance) and nobody can enter that area. This is due, especially for the limited or bad visible area on the opposite site of the pallet (operators view). During strapping, there must not be any hands or other body parts between strap and goods.

Power source, risk of injury

Before maintenance or repair works:

Switch off the strapping system by pressing the „OFF“ switch, the key has to be removed from the main switch and the Li-ion battery from the strapping system.



Caution!

Following hazards can result in minor or moderate injuries:

Strap coil, risk of injury

While changing the strap coil, 2 persons need to transport and lift it, if the weight of the roll is 44 lbs or heavier.

Tilting danger

Strapping pallets should, whenever possible, take place in areas with an even surface. When using the strapping system on inclined surfaces, after positioning and before strapping, the brakes of the castor wheels on the strap side have to be locked.



Attention!

Avoid damages on the strapping system:

Water damages

For cleaning of the strapping system do not use water or steam.

Visual inspection

Before using the strapping system for the first time, a visual inspection for external damage has to be done.

Use only original ErgoStrap spare parts!

Warranty and liability become invalid if other than ErgoStrap spare parts are used.

9.1 Emergency information

9.1.1 First aid measures

Symptoms caused by combustion gases or leaking fluids require medical attention.

After inhalation

Leave the area immediately. Move to fresh air. Consult a doctor.

After skin contact

Remove solid particles immediately. Rinse affected areas with plenty of water for at least 15 minutes. Then gently dab the affected skin area, do not rub dry. Remove contaminated clothing immediately. In case of redness or abnormalities, consult a doctor.

After eye contact

Rinse eyes cautiously with plenty of water for at least 15 minutes. Protect unaffected eye. Consult a doctor.

After ingestion

Drink plenty of milk or water and induce vomiting. Consult a doctor.

9.1.2 Fire fighting measures



Warning!

Inhalation of vapours may cause poisoning.

- ▶ Place on the side of the fire from which the wind comes
 - ▶ Use respiratory protection if possible.
1. If possible, carefully remove the Li-ion battery from the strapping system.
 2. Evacuate all persons from the immediate fire area.
 3. Use plenty of water or fire extinguishers of fire class D to fight the fire.
 4. Alert the fire brigade if the fire cannot be fought by yourself or gets out of control.

10. Service and repair

Your ErgoStrap is made out of galvanized steel, powder coated steel, stainless steel and highly wear resistant plastic and is basically maintenance free.

Clean the outside of the ErgoStrap with a damp cloth if it is extremely dirty.



Warning!

During all maintenance and service/repair works, the strapping system has to be switched off by pressing the „OFF“ switch, the key has to be removed from the main switch and the Li-ion battery removed from the strapping system.

10.1 Cleaning the ChainLance

Clean the ChainLance with acetone or petroleum if it has become dirty with oil. Always wear appropriate protective equipment.



Attention!

Do not place the ChainLance into cleaner.
Never use lubricants like grease or oil!

10.2 Replacing the ChainLance

1. Step

Cut off the strap in front of the white roll and fix it with an adhesive tape to the coil. Pull out the rest of the strap remained in the strapping system through the head piece of the ChainLance and dispose it.



Fig. 88

2. Step

(There are 2 options)

Option 1

Set the pallet width at the display of the strapping system to 39" and drive out the ChainLance until the joint of the reversing sledge folds up and locks into this position.



Fig. 89

Afterwards, switch off the strapping system by pressing the OFF button and remove the Li-ion battery from the strapping system. For this purpose, the cover of the Li-ion battery compartment has to be opened (by pulling at the wheel covers). (Fig. 90)



Fig. 90

Option 2

Switch off the strapping system by pressing the OFF button and remove the Li-ion battery from the strapping system. For this purpose, the cover of the Li-ion battery compartment has to be opened (by pulling at the wheel covers). (Fig. 90)



Fig. 91

91a

A second person presses downwards the „rocker“ of the locking unit (91a), which is connected with the magnet lock through the folding spring bolt. At the same time the other person pulls the reversing sledge out of the strapping system (Fig. 93).

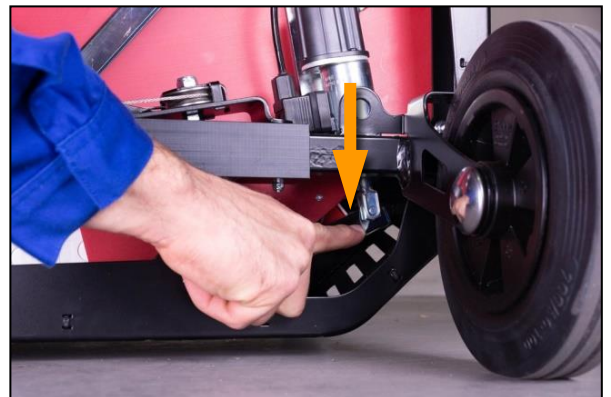

Fig. 92

Now, pull out the reversing sledge by about 39" and fold up the joint. (Fig. 94)



Fig. 93

3. Step

Pull the ChainLance out of the strapping system as shown and roll it up.



Fig. 94

4. Step

Push the new ChainLance in again in reversed order of the removal.



Fig. 95

By pushing the end piece of the ChainLance into the system, the end pieces preloaded by a spring (Fig.96), has to be aligned straight (Fig. 97). Press the chain links down with your finger and push them into the strapping system ...



Fig. 96



Fig. 97

... so that the end of the ChainLance can be inserted into the groove of the ChainLance (Fig. 98) in the central part of the strapping system (Fig. 100).



Fig. 98

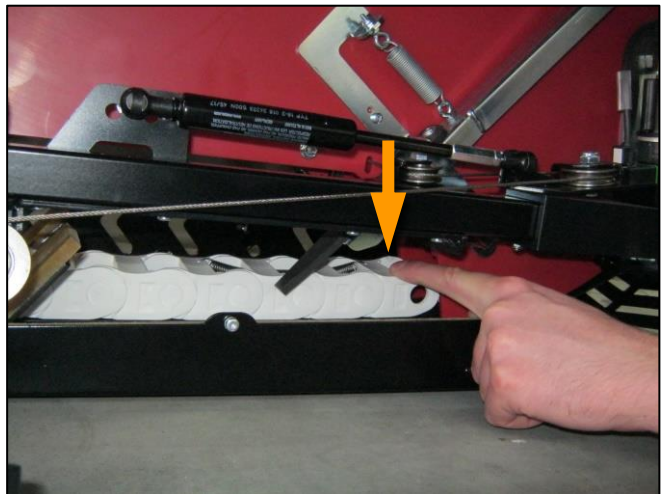

Fig. 99

Also for that, the preloaded chain links have to be pressed down with your finger (Fig. 99).

Groove of the ChainLance



Fig. 100

5. Step

Put the strapping system into operation in accordance with section 7.

10.3 Replacing the reversing sledge

1. Step

Cut off the strap in front of the white roll and fix it with an adhesive strip to the coil. Pull out the rest of the strap remained in the strapping system through the head piece of the ChainLance and dispose it.



Fig. 101

2. Step

Set the pallet width at the display of the strapping system to 39" and drive out the ChainLance...



Fig. 102

...until approx. 24" of the chain stands in an upward position. Then, switch off the strapping system by pressing the OFF button and remove the Li-ion battery from the system.



Fig. 103

3. Step

Push a screwdriver (blade width 1/5") between the wings of two chain links ...

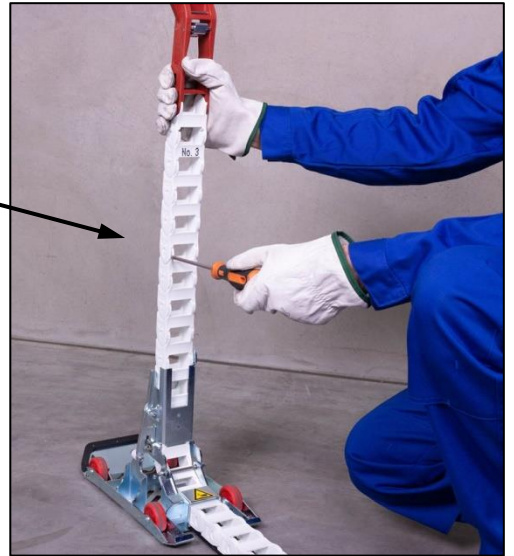

Fig. 104

... and slew the chain to the side by turning the screwdriver carefully ...



Fig. 105

... until the two chain links fully separate.

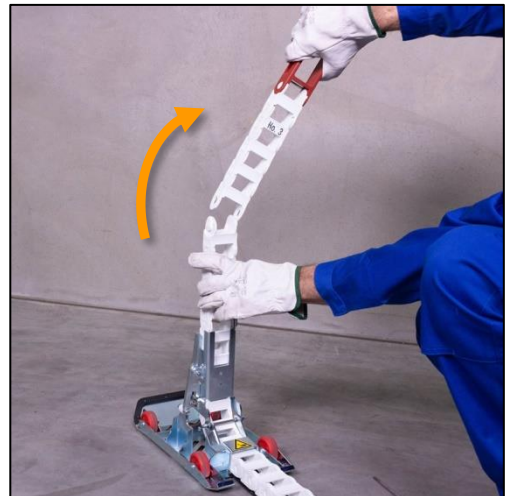

Fig. 106

4. Step

Push the ChainLance manually back into the strapping system until the ChainLance has completely moved out of the reversing sledge.



Fig. 107

5. Step

Place the reversing sledge on its top as illustrated and use a screwdriver to unscrew both screws of the length adjusting belt.



Fig. 108

6. Step

The fitting of the reversing sledge is done in the reversed order of the dismantling.



Attention!

Both screws of the length adjusting belt must be protected with medium-tight screw retaining varnish!

10.4 Replacing individual chain links

In case of broken individual chain links, the ChainLance can be opened as described under point 10.2 to replace those defective chain links.

It is temporarily also possible to remove a defective chain link without the need to insert a new chain link.



Attention!

After removing the chain link, the strapping system has to be restarted. After each restart, the control unit automatically adjusts to the correct zero position in accordance with point 8.4.



Note!

As the new shorter chain length is unknown to the control unit, it may happen that when driving out the chain completely, the end of the chain will not be recognized correctly any longer and the ChainLance will be pushed out over the driving gearwheel.

This can cause a malfunction. Therefore, missing chain links should be replaced as soon as possible.

10.5 Replacing the length adjusting belt

1. Step (dismantling)

Perform steps 1 to 5 listed in point 10.3 and continue with step 2.

2. Step

Open the cover „Li-ion battery compartment“ as described under point 7.2 „charging the Li-ion battery“.

Now, unlock the ball lock pin by pressing the release button and pull it out of the storage plate.

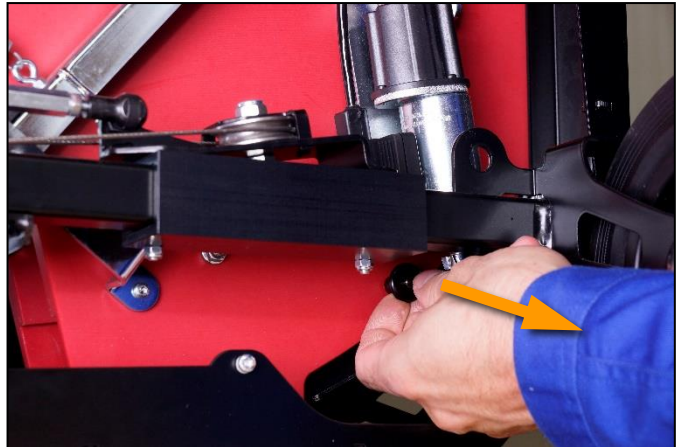

Fig. 109

3. Step

A second person presses downwards the „rocker“ of the locking unit which is connected with the magnet lock through the folding spring bolt. At the same time the other person pulls the length adjusting belt out of the strapping system.



Fig. 110

4. Step (installation)

Push the ChainLance all the way back into the strapping system so that you can see the groove of the length adjusting belt.

5. Step

Push the new length adjusting belt into the small groove below the groove for the ChainLance.

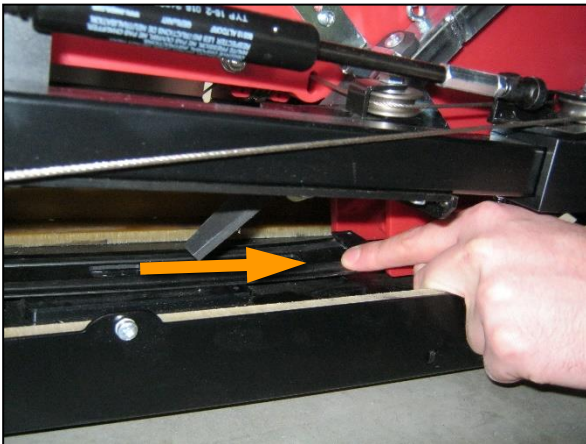

Fig. 111

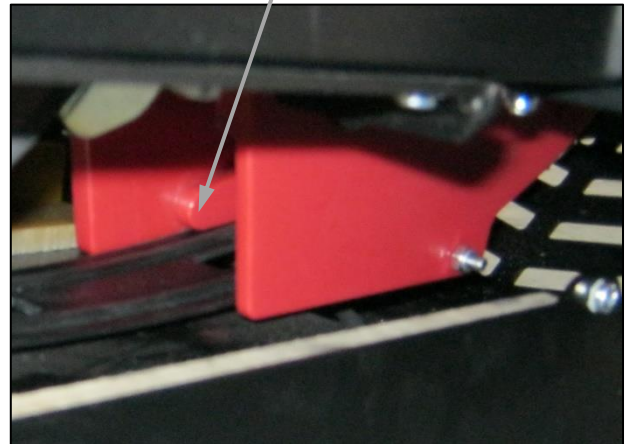

Fig. 112



Attention!

Make sure that the length adjusting belt is inserted into the lower groove and that it does not slide into the upper groove of the ChainLance.

6. Step

The further installation is done in the reversed order of the dismantling.

10.6 Changing the sealing head



Warning!

Improper handling of the electronic components can lead to defect or malfunction of the strapping system.

1. To prevent voltage flashover to electronic components during maintenance work, the person carrying out the maintenance must discharge himself (e.g. by touching a water pipe).
2. Observe the assembly and disassembly sequence in order to be able to safely discharge electrostatic charges.

1. Step

Drive out the Tool-Lift forwards so that the cover „display“ can be disassembled.



Fig. 113

2. Step

Remove the cover „display“ by pulling on the provided handle holes diagonally downwards. (The cover is fixed by magnets).



Fig. 114

3. Step

Unlock the red locking ring on the plug of the cable of the sealing head by turning it counter clockwise. Now, remove the plug.

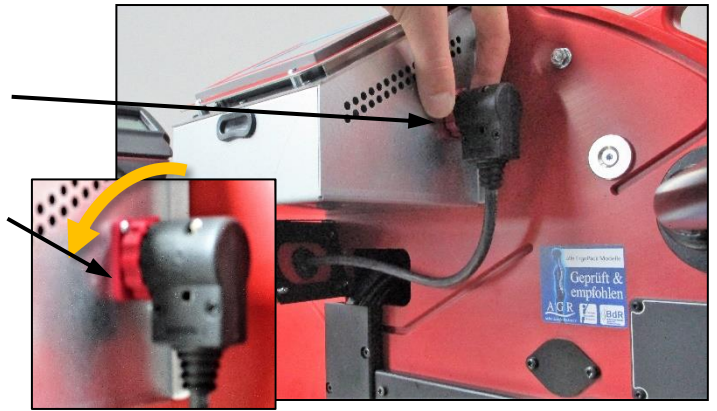

Fig. 115

4. Step

Remove the 4 screws of the red metal cover at the holder of the spiral cable.



Fig. 116

5. Step

Pull the cable with plug through the opening in the holder of the spiral cable.



Fig. 117

6. Step

Pull out the locking bolt for unlocking the sealing head and remove the sealing head.



Fig. 118

If your strapping system is equipped with the optional Triplex Tool-Lift:

Remove both screws M5 (4mm Allen wrench). These screws are secured with special wedge-lock washers (the wedge-lock washers can be reused).



Fig. 119

7. Step

The mounting of the sealing head is to be done in reversed order of the dismantling. When mounting the cover „display“, take care to engage it first at the display and then all along the groove of the storage plate.



Attention!

When mounting the sealing head again make sure that the rough tooth system of the two wedge-lock washers are facing each other (Fig. 120).

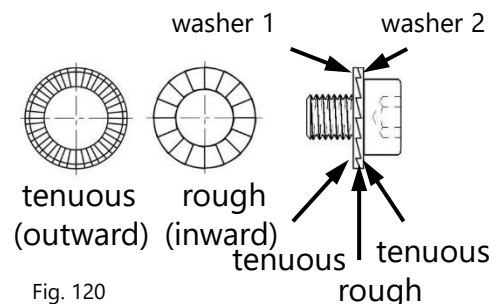

10.7 Changing the control box joystick unit



Warning!

Improper handling of the electronic components can lead to defect or malfunction of the strapping system.

1. To prevent voltage flashover to electronic components during maintenance work, the person carrying out the maintenance must discharge himself (e.g. by touching a water pipe).
2. Observe the assembly and disassembly sequence in order to be able to safely discharge electrostatic charges.

1. Step

Cut off the strap in front of the white roll and fix it with an adhesive strip to the coil. Pull out the rest of the strap remaining in the strapping system through the head piece of the ChainLance and dispose it.



Fig. 121

2. Step

Fold down the pivot arm.



Fig. 122

3. Step

Remove the cover „joystick“ by pulling on the handle holes, provided at the bottom side (the cover is fixed by magnets).



Fig. 123

4. Step

Fold the pivot arm upwards again.



Fig. 124

5. Step

First disconnect the plugs of the power cable, then the two motor cables on the opposite side and then all other plugs.

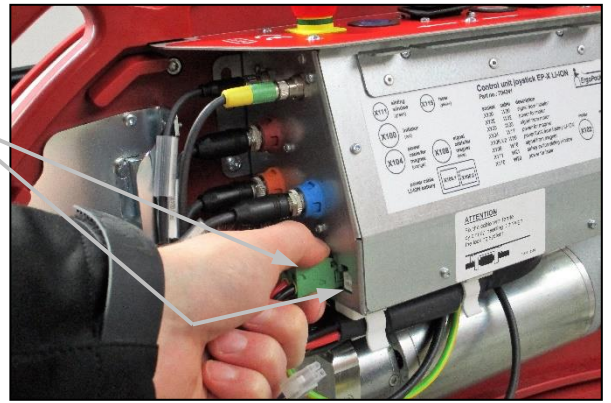

Fig. 125



Attention!

The plugs are secured with a screw socket which has to be unlocked by turning it counter clockwise. Remove the plugs afterwards only.

6. Step

Unclip the power cable from its holder on the underside of the control unit.



Fig. 126

7. Step

Remove the 4 screws on the side of the control unit.



Fig. 127

8. Step

Now carefully loosen the plug connections on the back of the control unit.



Attention!

Disconnect the earth cable (green-yellow) last.



Attention!

For disconnecting the plug of the black/red cable, you have to pull the flap of the plug.

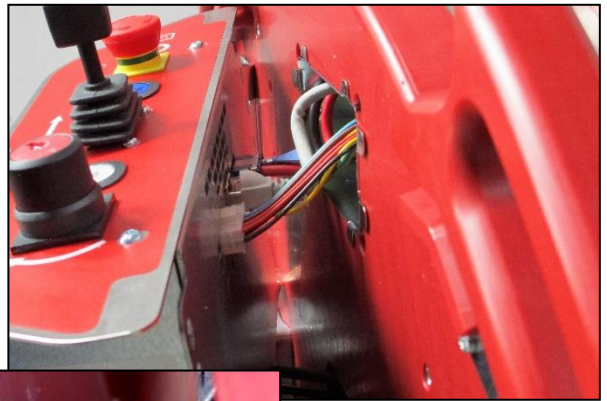

Fig. 128



9. Step

Remove the nut on the ground bolt/threaded stud and then pull off the ground cable and ground strap.

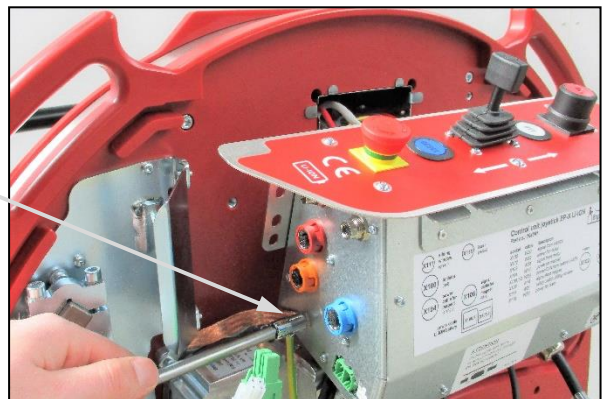

Fig. 129

10. Step

The installation of the control unit is done in the reversed order of the disassembling. While connecting the cables always take note of the information on the label (130a) located on the front side of the control unit.

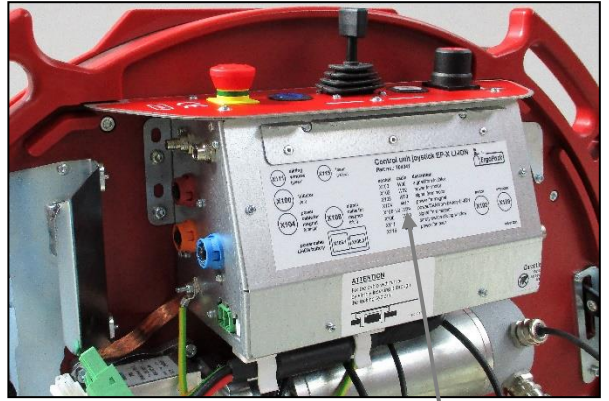

Fig. 130

130a



Attention!

The plug-in connection is positioned relative to one another through a plastic nose and groove. When having the correct position, connect the plug and secure it by the screw socket. This screw socket has to be closed by turning it clockwise. Only then, the function of the plug-in connection is ensured.

10.8 Changing the control box display unit



Warning!

Improper handling of the electronic components can lead to defect or malfunction of the strapping system.

1. To prevent voltage flashover to electronic components during maintenance work, the person carrying out the maintenance must discharge himself (e.g. by touching a water pipe).
2. Observe the assembly and disassembly sequence in order to be able to safely discharge electrostatic charges.

1. Step

At first, remove the control box joystick unit as described in section 10.7.

2. Step

Drive out the Tool-Lift forwards so that the cover „display“ can be disassembled.



Fig. 131

3. Step

Remove the cover „display“ by pulling on the provided handle holes diagonally downwards. (The cover is fixed by magnets).



Fig. 132

4. Step

Unlock the red locking ring on the plug of the cable of the sealing head by turning it counter clockwise. Now, remove the plug.

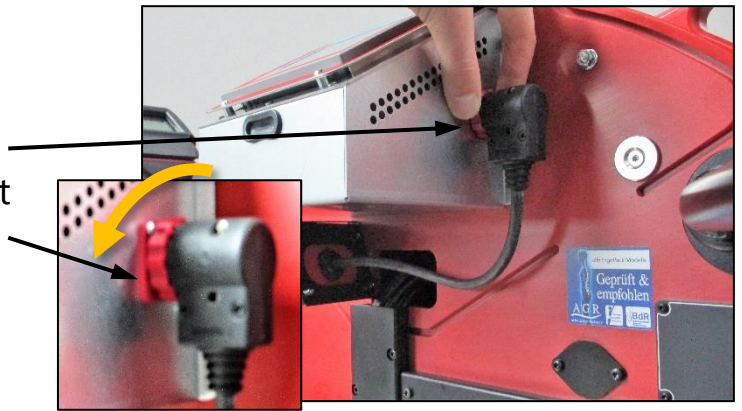

Fig. 133

5. Step

Remove the 4 screws on the side of the control unit and...



Fig. 134

... remove the control box and thereby pull the cable carefully through the cable duct.

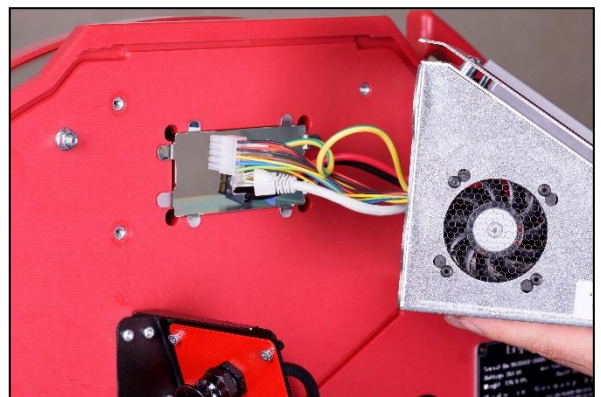

Fig. 135

6. Step

The installation of the control unit is done in the reversed order of the disassembling.

10.9 Changing the motor



Warning!

Improper handling of the electronic components can lead to defect or malfunction of the strapping system.

1. To prevent voltage flashover to electronic components during maintenance work, the person carrying out the maintenance must discharge himself (e.g. by touching a water pipe).
2. Observe the assembly and disassembly sequence in order to be able to safely discharge electrostatic charges.

1. Step

Cut off the strap in front of the white roll and fix it with an adhesive strip to the coil. Pull out the rest of the strap remaining in the strapping system through the head piece of the ChainLance and dispose it.



Fig. 136

2. Step

Fold down the pivot arm.



Fig. 137

3. Step

Remove the cover „joystick“ by pulling on the handle holes, provided at the bottom side (the cover is fixed by magnets).



Fig. 138

4. Step

Fold the pivot arm upwards again.



Fig. 139

5. Step

Unscrew the two plugs guided to the motor from the right side of the control box „joystick“ unit.



Attention!

The plugs are secured with a screw socket which has to be unlocked by turning it counter clockwise. Remove the plugs only afterwards.

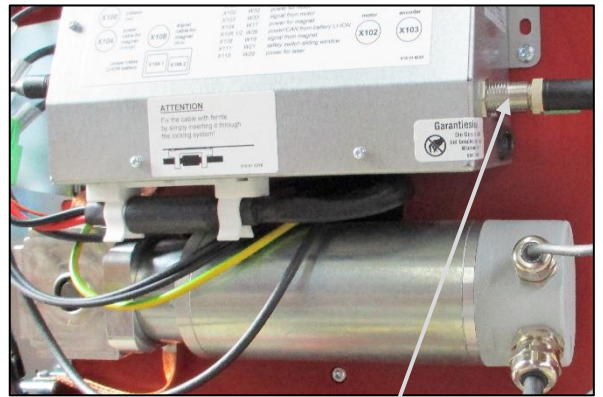

Fig. 140



Fig. 141

6. Step

First remove the 3 screws (142a) on the motor support plate, then remove the screw with the earth strap (142b) and ...

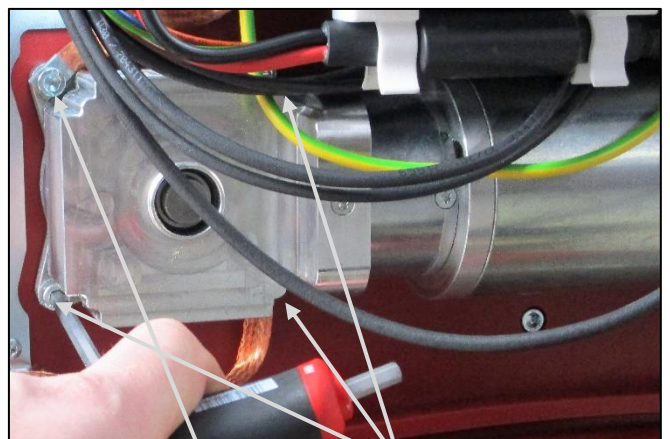

Fig. 142

142b

142a

... remove now the motor carefully.
Take care not to lose the feather key (143a).

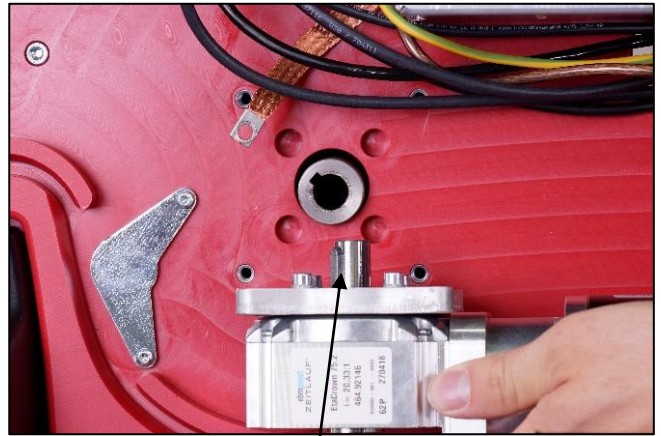

Fig. 143

143a

7. Step

The installation of the motor is done in the reversed order of the disassembling.



Attention!

The plug-in connection is positioned relative to one another through a plastic nose and groove. When having the correct position, connect the plug and secure it by the screw socket. This screw socket has to be closed by turning it clockwise. Only then, the function of the plug-in connection is ensured.

The feather key at the motor output has to be positioned exactly to the groove in the shaft.

10.10 Cleaning/replacing the tension wheel at the sealing head

Cleaning the tension wheel without disassembling

- There is an access hole (144a) in the protection cover below the motor. The tension wheel and the tooth plate can be cleaned with compressed air through this access hole.
- When heavily soiled, the tension wheel has to be disassembled.



Fig. 144

144a



Warning !

Wear eye protection when cleaning with compressed air!

Cleaning the tension wheel with disassembling / replacing the tension wheel

- Release 4 cylinder screws (Torx) (4), remove strap guide rear (5) and side cover (3).
- Remove tension wheel (1) carefully.
- Remove ball bearing (2) from tension wheel.
- Clean the tension wheel with compressed air.
- If the tension wheel teeth are covered with heavy dirt they must be cleaned carefully with the wire brush (6) supplied.
- Check tension wheel for worn teeth. If a few teeth are broken, replace tension wheel (observe direction, see arrow).

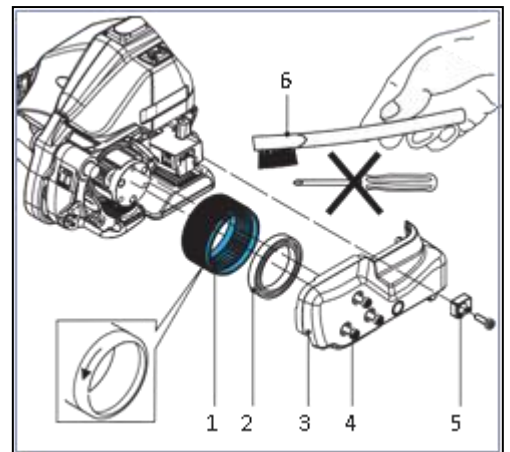

Fig. 145

- **Installation** is done in the reversed order of the disassembling.
- Grease interior gear teeth of the tension wheel lightly with Klüber grease GBU Y 131 (Microlube).



Attention!

The tension wheel is extremely sensitive when it comes into contact with hard, especially metallic objects. A hard object, such as a screwdriver or similar, must not be used under any circumstances whatsoever for cleaning. The tension wheel must not be cleaned in an installed state when it is rotating. Risk of breakage teeth.

10.11 Cleaning/replacing the tooth plate at the sealing head



Warning !

Wear eye protection when cleaning with compressed air!

- Remove pan head screw (1).
- Lift the rocker lever towards the handle and remove tooth plate (2).
- Clean tooth plate with compressed air.
- If the tooth plate teeth are covered with heavy dirt, they must be cleaned carefully with the wire brush supplied.
- Check tooth plate for worn teeth, if necessary, replace tooth plate.
- **Installation** is done in the reversed order of the disassembling.
- Secure pan head screw (1) with screw locking varnish "medium-tight".

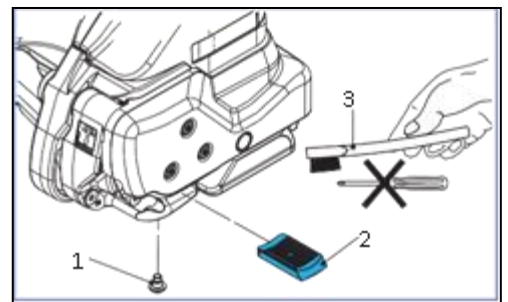

Fig. 146



Attention!

The tooth plate (2) must be placed so that it can move freely in the rocker!

10.12 Replacing the cutter at the sealing head

- Release 4 cylinder screws Torx (3), remove strap guide rear (4) and side cover (2).
- Release cylinder screw Torx (5), take care that you do not lose the compression spring (7), remove knife (1) with flanged bushing (6) and replace knife.

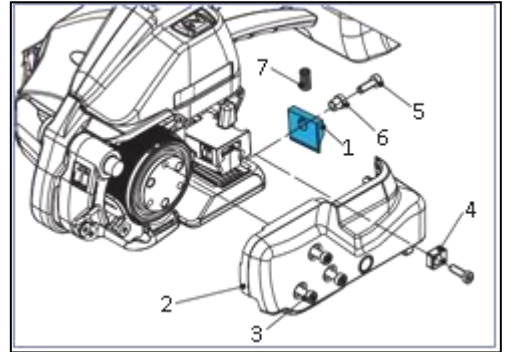

Fig. 147

- **Installation** is done in the reversed order of the disassembling.
- Before installing the knife (1), check that the compression spring (7) on top of the knife is still mounted.
- Secure the pan head screw (5) with screw locking varnish "medium-tight".

10.13 Li-ion Battery Error Messages and cleaning

Error	Possible solution
All LEDs flash	Battery defective. ▶ Please contact ErgoStrap service partner..
First LED flashes	Battery empty. ▶ Charge battery.
LEDs are off	▶ Switch on the battery. ▶ Check connection to strapping system/charger.
The battery does not charge	▶ Check the connection of the charger to the socket and to the charger.
The battery does not supply power	▶ Switch on the battery. ▶ Check connection to strapping system..
Mechanical defect	▶ Have checked by ErgoStrap service partner.
Battery does Not work.	▶ Contact your ErgoStrap service partner.

Cleaning:

If necessary, clean the battery with a dry cloth.

Keep the battery and contacts clean and dry. Clean dirty contacts with a dry cloth.



Note!

Send the defective Li-ion battery to the ErgoStrap service partner.

When

shipping lithium-ion batteries, observe the interpretation and enforcement of the relevant regulations of the federal state authorities, see chapter 2.7.

10.14 Li-ion Charging Station/Charger

Error messages and cleaning

Error	Possible solution
Red LED flashes	Battery fault. <ul style="list-style-type: none">▶ Disconnect the battery from the charger.▶ Please contact ErgoStrap service partner.
Red LED lights up	Charger malfunction. <ul style="list-style-type: none">▶ Check the connection of the charger to the socket and to the battery.▶ Check the function of the fan on the charger.▶ Please contact ErgoStrap service partner.
LEDs are off	<ul style="list-style-type: none">▶ Check the connection of the charger to the socket.▶ Check the mains switch on the charger.▶ Check the mains socket.▶ Please contact ErgoStrap service partner.



Attention!

Do not make any modifications to the charger/charging station. Repairs may only be carried out by authorised specialist personnel.

Cleaning:

Disconnect the charger from the mains and then clean it with a dry or at most damp cloth.

Keep the charger clean and dry.

Send the defective Li-ion charger to your ErgoStrap service partner.

11. Software Updates



Attention!

Updates on the control units „Joystick“ and „Display“ only through trained and properly instructed staff. The necessary access code will be provided by your ErgoStrap service partner.

1. Step

Remove the cover „joystick“ as described in section 10.7 step 1 to 4 and take off the cover „display“ in accordance with the instructions in point 10.8, step 1 to 3.

2. Step

Remove the rubber plugs from the USB-ports (148a/149a).



Fig. 148

148a



Fig. 149

149a

3. Step

Press the „F3” button (1) on the display and click „next” (2) until page 6 (3) of the menu appears. Unlock the lock (4) with the corresponding access code.

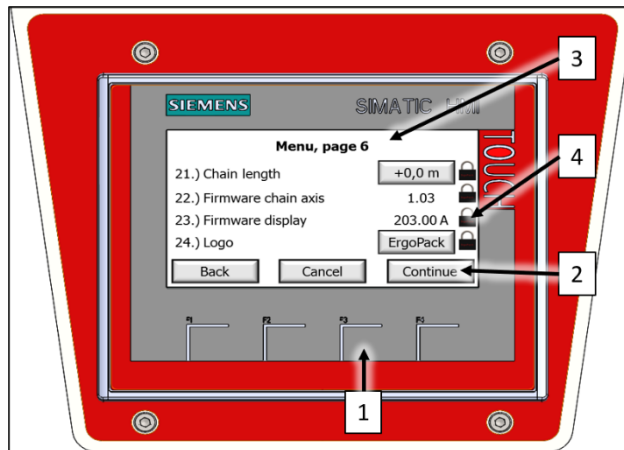

Fig. 150

4. Step

Firmware chain axis:

After unlocking, insert the USB stick with the current firmware into the USB port of the control unit „joystick” and start the update by confirming with „OK”.

As soon as the update was finished, the new version will be shown on the display!

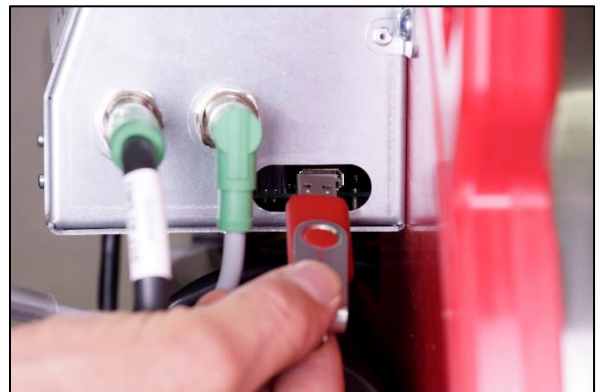

Fig. 151

5. Step

Firmware display:

After unlocking, insert the USB stick with the current firmware into the USB port of the control unit „display” and start the update by confirming with „OK”. Proceed further as described on page 108.



Fig. 152

6. Step

Procedure of the update "display":

After confirmation, the start center appears.

Select now „settings“.

Click on the file „Service & Commissioning“.

Select „Restore“

Search your USB-stick by clicking on „Search“. After your USB-stick was found, scroll down and click on „>“ to go to the next step.

Start searching the backup file by clicking on „Search“. After the backup file was found, change to the next step by clicking „>“ at the bottom right.

By confirming with „Accept“, the upload process starts automatically and the installation begins. As soon as the message „EMERGENCY STOP pressed“ appears, remove the USB-stick. After unlocking the „EMERGENCY STOP“, press „RESET“. Now you are in the main menu.

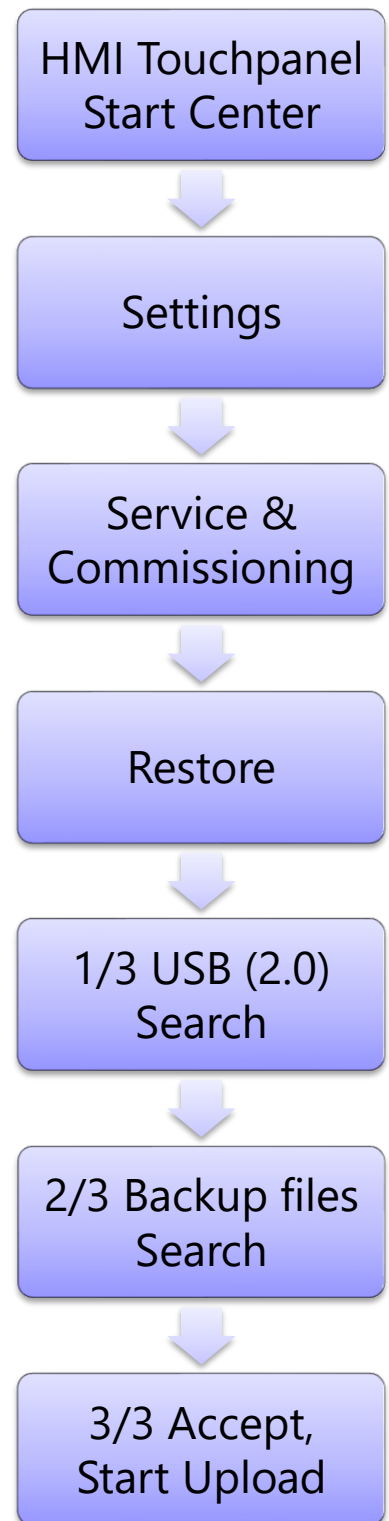

Fig. 153

12. Personal protective equipment



Inform yourself!

Before usage of the strapping system, the operating instructions have to be read carefully and understood. Service and maintenance on the strapping system have only to be done by trained staff.



Wear a safety helmet!

When strapping pallets higher than 47", a safety helmet has to be worn.

The duty wearing a helmet can be avoided, if the user was taught about the risk of injury by the plastic chain falling and that particular caution is required.

This instructions have to be recorded in writing.



Protect yourself!

Wear eye and hand protection (cut proof gloves) and also safety shoes.

13. General safety warnings for power tools



Warning !

Read all safety warnings and instructions. Failure to follow the warnings and instructions may result in electric shock, fire and/or serious injury.

Save all warnings and instructions for future reference.

The term „power tool“ in the warnings refers to your mains-operated (corded) power tool or battery-operated (cordless) power tool.

Work area safety

- a) **Keep the work area clean and well lit.** Cluttered or dark areas invite accidents.
- b) **Do not operate power tools in explosive atmospheres, such as in the presence of flammable liquids, gases or dust.** Power tools create sparks which may ignite the dust or fumes.
- c) **Keep children and bystanders away while operating a power tool.** Distractions can cause you to lose control.

Electrical safety

- a) **Power tool plugs must match the outlet. Never modify the plug in any way. Do not use any adapter plugs with earthed (grounded) power tools.** Unmodified plugs and matching outlets will reduce the risk of electric shock.
- b) **Avoid body contact with earthed or grounded surfaces such as pipes, radiators, ranges and refrigerators.** There is an increased risk of electric shock if your body is earthed or grounded.

- c) **Do not expose power tools to rain or wet conditions.** Water entering a power tool will increase the risk of electric shock.
- d) **Do not abuse the cord. Never use the cord for carrying, pulling or unplugging the power tool. Keep the cord away from heat, oil, sharp edges or moving parts.** Damaged or entangled cords increase the risk of electric shock.
- e) **When operating a power tool outdoors, use an extension cord suitable for outdoor use.** Use of a cord suitable for outdoor use reduces the risk of electric shock.
- f) **If operating a power tool in a damp location is unavoidable, use a residual current device (RCD) protected supply.** Use of an RCD reduces the risk of electric shock.

Personal safety

- a) **Stay alert, watch what you are doing and use common sense when operating a power tool. Do not use a power tool while you are tired or under the influence of drugs, alcohol or medication.** A moment of inattention while operating power tools may result in serious personal injury.
- b) **Use personal protective equipment. Always wear eye protection.** Protective equipment such as dust masks, non-skid safety shoes, hard hat or hearing protection used for appropriate conditions will reduce the risk of personal injuries.
- c) **Prevent unintentional starting. Ensure the switch is in the off-position before connecting to the power source and/or battery pack, picking up or carrying the tool.** Carrying power tools with your finger on the switch or energising power tools that have the switch on, invites accidents.
- d) **Remove any adjusting key or wrench before turning the power tool on.** A wrench or a key left attached to a rotating part of the power tool may result in personal injury.

- e) **Do not overreach. Keep proper footing and balance at all times.** This enables better control of the power tool in unexpected situations.
- f) **Dress properly. Do not wear loose clothing or jewellery. Keep your hair, clothing and gloves away from moving parts.** Loose clothes, jewellery or long hair can be caught in moving parts.
- g) **If devices are provided for the connection of dust extraction and collection facilities, ensure these are connected and properly used.** Use of dust collection can reduce dust-related hazards.

Power tool use and care

- a) **Do not force the power tool. Use the correct power tool for your application.** The correct power tool will do the job better and safer at the rate for which it was designed.
- b) **Do not use any power tool with a defective switch.** Any power tool that can not be controlled with the switch is dangerous and must be repaired.
- c) **Disconnect the plug from the power source and/or the battery pack from the power tool before making any adjustments, changing accessories, or storing power tools.** Such preventive safety measures reduce the risk of starting the power tool accidentally.
- d) **Store power tools out of the reach of children and do not allow persons unfamiliar with the power tool or these instructions to operate the power tool.** Power tools are dangerous in the hands of untrained operators.
- e) **Maintain power tools. Check for misalignment or binding of moving parts, breakage of parts and any other condition that may affect the power tool's operation. If damaged, have the power tool repaired before use.** Many accidents are caused by poorly maintained power tools.
- f) **Keep cutting tools sharp and clean.** Properly maintained cutting tools with sharp cutting edges are less likely to bind and are easier to control.

- g) Use the power tool, accessories and tool bits etc. in accordance with these instructions, taking into account the working conditions and the work to be performed.** Use of the power tool for operations different from those intended could result in a hazardous situation.

Battery tool use and care

- a) Recharge the battery packs only with the charger specified by the manufacturer.** A charger that is suitable for one type of battery pack may create a risk of fire when used with another battery pack.
- b) Use power tools only with specifically designated battery packs.** Use of any other battery packs may create risk of injury and fire.
- c) When the battery pack is not in use, keep it away from metal objects, like paper clips, coins, keys, nails, screws or other small metal objects, that can make a connection from one terminal to another.** Shorting the battery terminals together may cause burns or fire.
- d) Under abusive conditions, liquid may be ejected from the battery; avoid contact. If contact accidentally occurs, flush with water. If liquid contacts eyes, additionally seek medical help.** Liquid ejected from the battery may cause irritation or burns.

Service

- a) Have your power tool serviced by a qualified repair person using only identical replacement parts.** This will ensure that the safety of the power tool is maintained.

