

Original Operating Instructions

**For ErgoPack
RE**

Declaration of conformity

EU declaration of conformity (for the purposes of the EU machine directive 2006/42/EG)

We, ErgoPack Deutschland GmbH
Hanns-Martin-Schleyer Str. 21
89415 Lauingen

hereby declare, that the Ergonomic Pallet Strapping Systems type "ErgoPack RE", to which this declaration refers, complies with the respective relevant and basic health and safety requirements of the EU directives because of their concept, type of construction and the model we have brought on to the market.
This declaration loses its validity if a change is made to the system without our permission.

Respective
EU directives: EU Machine directive (2006/42/EG)
EU Guideline on electromagnetic compatibility
(2014/30/EU)

Applied standards: EN 12100: 2010
EN 415-1: 2014
EN 415-8: 2008
EN 61000-4-3: 2006
EN 55011: 2016

Since strapping system : EP10152788
Since year of manufacture: 2024

Lauingen, 1st of February, 2024



Witali Neumann
CEO

Authorised representative for publishing technical documentation:
ErgoPack Deutschland GmbH
Hanns-Martin-Schleyer Str. 21
89415 Lauingen

Declaration of conformity

UK Declaration of Conformity

We, ErgoPack Deutschland GmbH
Hanns-Martin-Schleyer Str. 21
89415 Lauingen, Germany

hereby declare, that the Ergonomic Pallet Strapping Systems type "ErgoPack RE", to which this declaration refers, comply with the respective relevant and basic health and safety requirements of the United Kingdom directives because of their concept, type of construction and the strapping systems we have brought on to the market. This declaration loses its validity if a change is made to the system without our permission.

Respective United Kingdom directives: Supply of Machinery (Safety) Regulations 2008 (UK SI 2008 No. 1597)
Electromagnetic Compatibility Regulations 2016 (UK SI 2016 No. 1091)

Applied standards BS EN ISO 12100: 2010
BS EN 415-1: 2014
BS EN 415-8: 2008
BS EN 61000-4-3: 2006
BS EN 55011: 2016

Since strapping system: EP10152788
Since year of manufacture: 2024

Lauingen, 1st of February, 2024



Witali Neumann
CEO

Authorised representative for publishing technical documentation:
ErgoPack Deutschland GmbH
Hanns-Martin-Schleyer-Str. 21
D-89415 Lauingen

Table of contents

1.	Validity of the operating instructions	7
2.	General	8
2.1	Moving the strapping system	8
2.2	Parking the strapping system	8
2.3	Work area space requirement	9
2.4	Environmental conditions	9
2.5	Energy supply Li-ion charger/battery	10
2.6	Notes on environmental protection	11
2.6.1	Disposing of the Li-ion battery	11
2.7	Notes on transport	12
2.7.1	Shipping the Li-ion battery	12
2.7.2	Transporting the Li-ion battery on the road	12
2.8	Meaning of warning symbols, presentation conventions	13
2.8.1	Explanation of symbols	13
2.8.2	Explanation of the safety representation	14
3.	Recommendations for protective measures	15
3.1	Safety regulations for battery and charger	16
3.1.1	General safety instructions for Li-ion batteries	17
3.1.2	General safety instructions Charger	17
3.1.3	Safety instructions for charging	18
3.1.4	Safety instructions for cleaning the battery and charger	18
3.1.5	Safety instructions for the storage of the Li-ion battery	19
3.1.6	Safety instructions for implant carriers	19
4.	Description	20
4.1	Design	20
4.2	Control panel strapping system	21
4.3	Touch display strapping system	21
4.4	Li-ion battery	22
4.4.1	General view Li-ion battery	22
4.4.2	LED display Li-ion battery	23

4.5	Display and commissioning of the Li-ion battery chargingstation/charger	24
4.5.1	General view Li-ion battery charging station	24
4.5.2	General view Li-ion battery charger	25
4.5.3	Commissioning Li-ion battery charging station/charger	26
5.	Technical data	287
5.1	Strapping system	27-28
5.2	Li-ion battery	29
5.3	Li-ion battery - Charging station/charger	30
6.	Intended use	31
7.	Commissioning	32
7.1	Li-ion battery-charging station/charger	32
7.2	Charging the Li-ion battery	32-34
7.3	Switching on the strapping system	35
7.4	Setting the date and time	36-37
7.5	Setting pallet width	38
8.	Operation	39
8.1	Strapping with Velcro tape	39-43
8.2	Wind up Velcro tape	44-45
8.3	Strapping with tension belt	46-48
8.4	Wind up tension belt	49-50
9.	Risks	51-54
9.1	Emergency information	54
9.1.1	First aid measures	54
9.1.2	Firefighting measures	55

10. Service and repair	56
10.1 Cleaning the ChainLance	56
10.2 Replacing the ChainLance	57-60
10.3 Replace stiffened chain section (2m) incl. head piece	61-62
10.4 Replacing the reversing sledge	63
10.5 Replacing individual chain links	65
10.6 Replacing the length adjusting belt	65-66
10.7 Replace the fork of the winding device	67
10.8 Replace the clamping lock of the winding device	68
10.9 Changing the control box joystick unit	69-72
10.10 Changing the control box display unit	73-74
10.11 Changing the motor	75-77
10.12 Li-ion Battery Error Messages and cleaning	78
10.13 Li-ion Charging Station/Charger Error messages and cleaning	79
11. Software Updates	80-82
12. Personal protective equipment	83
13. General safety warnings for power tools	84-87

1. Validity of the operating instructions

These operating instructions are valid for the following models:

ErgoPack RE

Strapping system with electrical drive, electronically controlled via joystick, with winding device for reusable straps.

2. General

2.1 Moving the strapping system

The strapping system can be pushed in an upright position with the two hand grips (Fig.1). For pushing it you must release the brakes of the two guide rolls on the strap side (Fig.1a).

2.2 Parking the strapping system

After having parked the strapping system you have to lock up the brakes of the two guide rolls (Fig.1a) on the strap side to avoid that the system is rolling away accidentally.

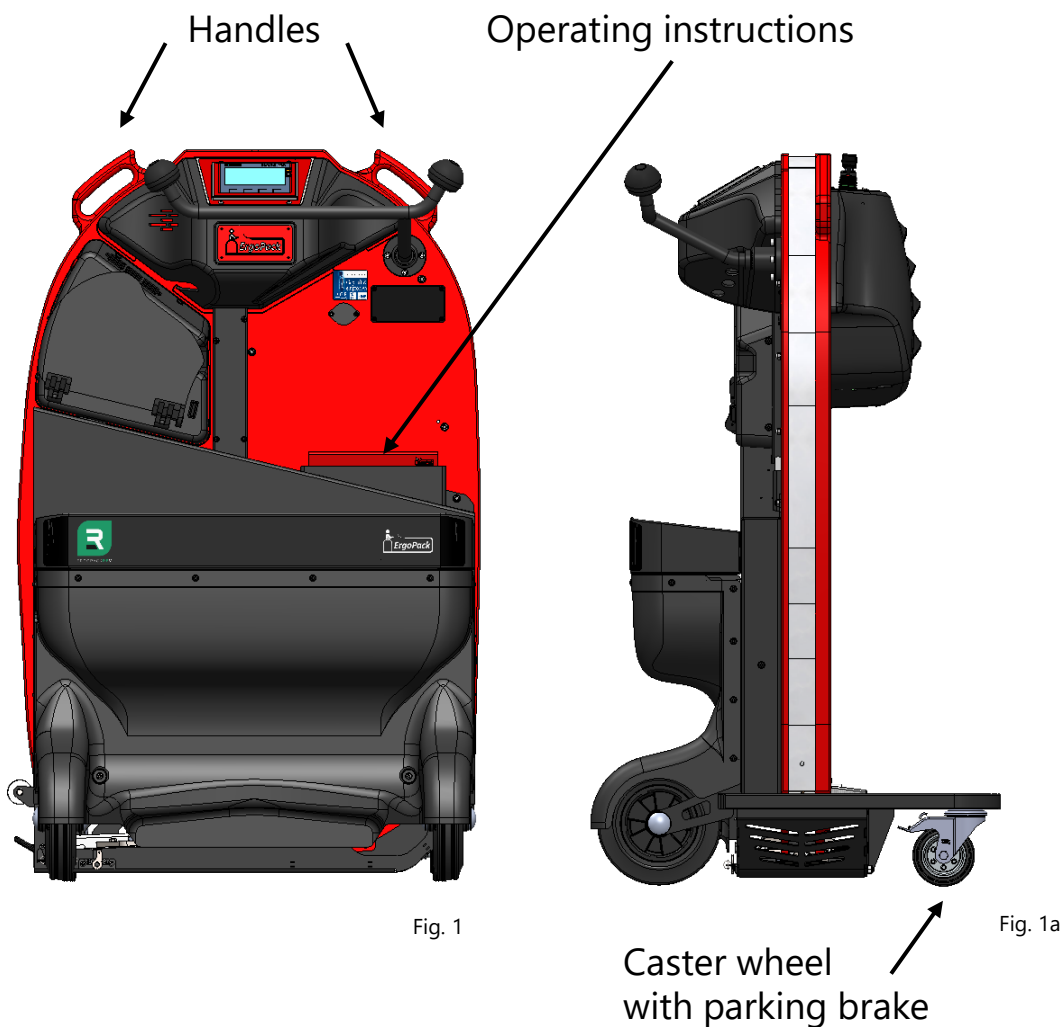

Fig. 1

Fig. 1a

Caster wheel
with parking brake

2.3 Work area space requirement

For a safe operation while strapping, the system has to be positioned correctly in front of the pallet. Therefore, a free area of at least 1,20 m width in front of the pallet to be strapped is required.

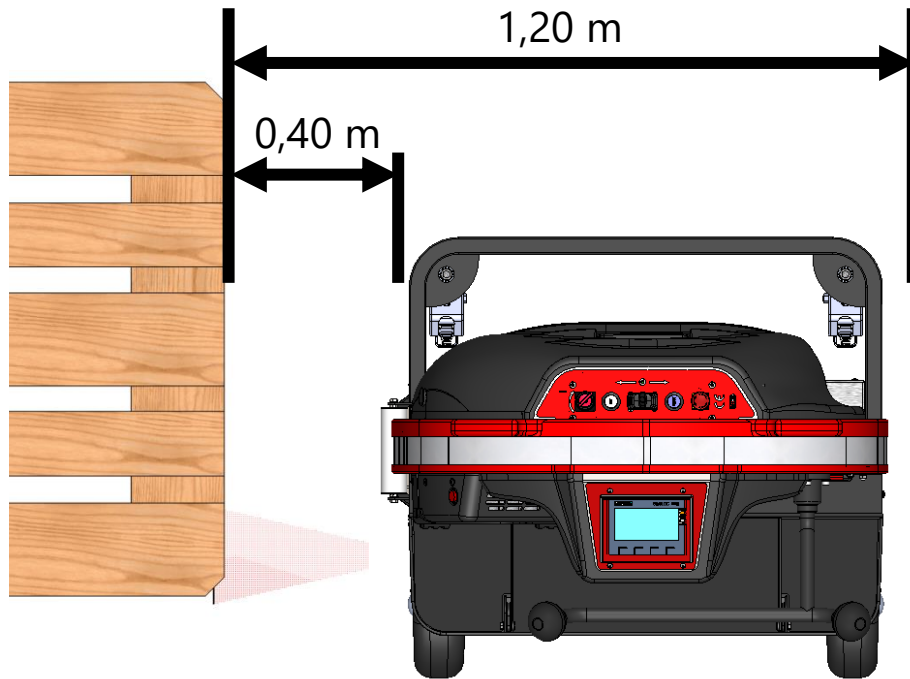

Fig. 2

2.4 Environmental conditions

The strapping system is only to be used in a covered dry area, otherwise the risk of an electric shock can not be ruled out.

The ambient temperature during operation must not exceed 50°C and not fall below 0°C.

For the strapping system, an electrically conductive floor is recommended.

2.5 Energy supply Li-ion charger/battery

Li-ion charger

	wide range charger
Operating voltage:	100-240 V
	50/60 Hz
Rated power consumption:	up to approx 650W
Charging current (nominal):	up to 10A

Li-ion battery

Weight:	approx 5,0 kg
Charging time:	approx 3,5 hours
Voltage (nominal):	36,3 V
Capacity (nominal):	24,15 Ah
Working temperatur range:	0°C to 40°C
Numbers of strappings:	Up to 1200 strappings with standard strapping*
Service life:	approx 80% residual capacity after approx 1000 charging cycles

***standard strapping:**

Band: 5m Velcro tape (orange)

Pallet: pallet width 0,8 m, pallet height 1,15 m

Strapping speed: fast

Room temperature: 20°C

2.6 Notes on environmental protection

Physical or chemical materials injurious to health have not been used for manufacturing the strapping system.

Concerning the waste disposal, valid national rules and regulations have to be considered. Take care about disposing packaging, the product itself and parts accordingly.

2.6.1 Disposal of the Li-ion battery

Do not dispose of the Li-ion battery in household waste. It must be disposed of properly and in an environmentally friendly manner by a disposal company. Disposal may vary from region to region or may be subject to country-specific regulations. To avoid short circuits, discharge the battery completely and tape the terminals with adhesive tape.

If the rechargeable battery is not disposed of properly, it may cause a fire and leakage of substances that are hazardous to health and the environment.

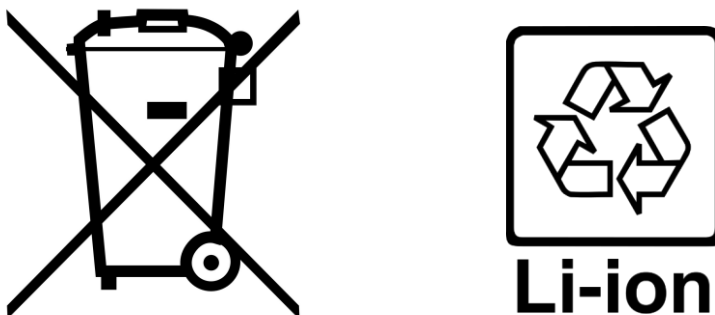

Fig. 3

2.7 Notes on transport

2.7.1 Shipping the Li-ion battery pack

The Li-ion battery is considered dangerous goods and may only be packed and shipped by trained persons. Please contact your ErgoPack service partner in this regard.

2.7.2 Transporting the Li-ion battery on the road

Private users may transport the battery on the road without any restrictions.

Commercial users or third parties carrying out transport must observe the relevant dangerous goods requirements for lithium-ion batteries.

2.8 Meaning of warning symbols, presentation conventions

2.8.1 Explanation of symbols



General warning sign



Warning of explosion and fire caused by short circuit, overheating or other electrical/mechanical misuse



Warning against laser radiation



Warning of crushing hazards



No open flame or high heat. Danger of explosion and fire.



Do not operate for persons with pacemakers or implanted defibrillators.



Compliant with the relevant European directives



Symbol for lithium-ion batteries (contains recyclable material)

Li-ion

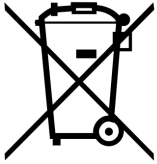

Do not dispose of in household waste



Follow instructions

2.8.2 Explanation of the safety representation



Warning!

Marks a hazard with moderate risk.
If not avoided, it can result in death or serious injury.



Caution!

Marks a hazard with a minor risk.
If not avoided, it can result in a minor or moderate injury.



Attention!

Marks a situation to be considered.
If not considered, it can lead to material damage or poor operating results.



Note!

Marks useful, additional information.

3. Recommendations for protective measures

These operating instructions will help you to understand the strapping system and how to use it according to regulations. The operating instructions contain important notes on how to use the strapping system safely, properly and economically.

Adhering to the notes helps you to avoid dangers, repairs and down times and also increases the reliability and life span of the strapping system.



Note!

The operating instructions must be available at the place where the strapping system is used (see Fig. 6).

Before using the strapping system for the first time, the operating instructions have to be read, understood and used by everybody who works with the system. These works include operation, maintenance and repair!

See chapter 8 and chapter 10.

In addition to the operating instructions and the rules in the country and place of use for the prevention of accidents, the recognized special rules for working safely and according to proper and professional standards also have to be respected.

In order to protect the strapping system against unauthorized access, it is recommended to remove the key from the main switch and remove the Li-ion battery from the strapping system.

The key should be kept safe from unauthorized access.

3.1 Safety regulations for battery and charger

Lithium-ion batteries can e.g. drop, explode and burn if handled improperly. Observe the safety instructions point 3.1 to 3.1.6 to minimise the risk.

- Check the plug and the cable before each use and have them replaced by a specialist if they are damaged.
- The charger is intended only for the batteries supplied with the strapping system. Do not charge any batteries from other manufacturers, use original spare parts only.
- Protect the charger and Li-ion battery against moisture; operate them in dry rooms only.
- Do not open the Li-ion battery and protect it from shock, heat and fire. Danger of explosion!
- Store batteries in a dry frost-proof place. The ambient temperature must not exceed +60°C and must not fall below -20°C.
- Damaged batteries may not be reused and must be disposed of properly.



Note!

- Keep the connection plug of the charger and the ErgoPack system away from non-related objects and dirt.

3.1.1 General safety instructions for Li-ion batteries

- Remove the battery from the strapping system before transporting or storing it. There is a risk of injury if the system is activated unintentionally.
- Only operate the battery and accessories when they are in perfect condition.
- Do not use a defective or damaged battery.
- Only use batteries that are approved for your systems (original ErgoPack battery).
- Persons with reduced physical, sensory or mental capabilities or lack of experience and knowledge must not use the battery and charger unless they are supervised or instructed to do so by a person responsible for their safety.
- Do not short-circuit the battery.
- Do not subject the battery to mechanical shocks.
- Do not open or disassemble the battery.
- Avoid large temperature changes.
- Protect the battery from heat above 60 °C and fire. Excessive temperatures can cause liquid to leak from the battery and damage the battery casing. Avoid contact with the liquid.
- Do not immerse the battery in liquids.
- Do not use the battery with a defective connection cable or defective contacts.
- For disposal of the battery, see chapter 2.6.

3.1.2 General safety instructions Charger

- Check the charger housing, cables and plugs for damage (e.g. cracks, changes to the metal surfaces on the plugs or deformation) before using it. Do not use the charger if it is damaged.
- Only connect the charger to suitable mains sockets.
- Do not open the charger, reach inside the charger with tools or insert anything into the charger.

3.1.3 Safety instructions for charging

- Read the instructions for the charger before charging.
- Operate the charger only in enclosed spaces that are ventilated, dry and dust-free. Do not cover the unit.
- Make sure that the charging current and voltage are suitable for your battery. You will find this information on the type plates or in the documentation supplied.
- Charge the battery before use.
- Only charge Li-ion batteries. Do not charge lead-acid, NiCd, NiMh or non-rechargeable batteries.
- Supervise the battery and charger during a charge.
- Do not charge overheated batteries. Stop charging if the battery becomes too hot ($>60^{\circ}\text{C}$). The battery must be cooled down to ambient temperature before charging. If there is a smell or smoke or if the battery is too hot to touch, stop charging immediately and contact the battery manufacturer.
- After charging is complete, disconnect the mains plug and the charging plug.

3.1.4 Safety instructions for cleaning the battery and charger

- Keep the battery and contacts clean and dry. Clean dirty contacts with a dry cloth.
- Do not clean the battery with solvents (i.e. thinner, alcohol, oil, corrosion protection) or cleaning agents.
- Do not clean the battery with a water jet, high-pressure cleaner or steam cleaner.
- Keep the charger clean and dry. Disconnect all plugs before cleaning the charger. Clean the charger with a dry or at most damp cloth.

3.1.5 Safety instructions for storing the Li-ion battery pack

- Remove the battery from the strapping system or disconnect it from the charger when not in use.
- Store the battery in a dry, well-ventilated place away from flames and food.
- Do not store the battery near heating appliances and protect it from direct sunlight.
- Do not store the battery near hot or flammable objects. There is a risk of explosion.
- Keep small metal objects away from the battery. Danger of short circuit.
- Temperature: -20 to 60 °C

3.1.6 Safety instructions for implant users

- For technical reasons, electromagnetic (non-ionising) radiation is generated at the electrical cables. Implant carriers must not be in the direct vicinity of the radiation.
- Electrostatic charges can be generated during the winding and unwinding of the strapping/belt and due to the friction between the chain and the side storage plates, which are made of plastic. The strapping system is designed in such a way that these charges can be dissipated into the floor. However, there is still a risk that they will be discharged via the user, which poses a risk to implant wearers.

4. Description

4.1 Design



Fig. 4



Fig. 5

Control panel
Control display
Easy-Move-Assistant



Fig. 6

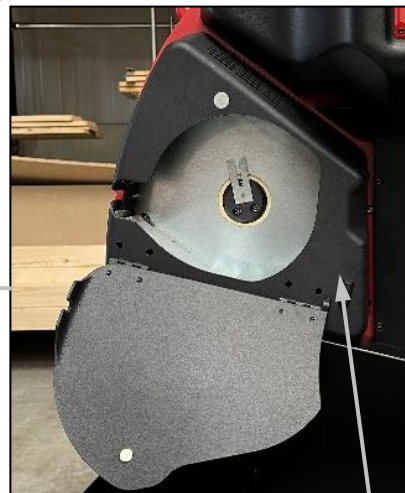

Fig. 7

Winding device
Operating instructions
Covering of battery box

4.2 Control panel strapping system



Main switch (power supply 0/1)

OFF switch (disconnects the power supply)

Joystick (moving the ChainLance in and out with precision speed control)

Reset switch (function check while switching on and acknowledging of malfunctions)

EMERGENCY STOP switch (stops the strapping system)

Fig. 8

4.3 Touch display strapping system



Fig. 9

Touch display for setting all parameters at the strapping system, such as pallet width.

Function key F1 – F4:

- F3 Menu

4.4 Li-ion battery

4.4.1 General view Li-ion battery

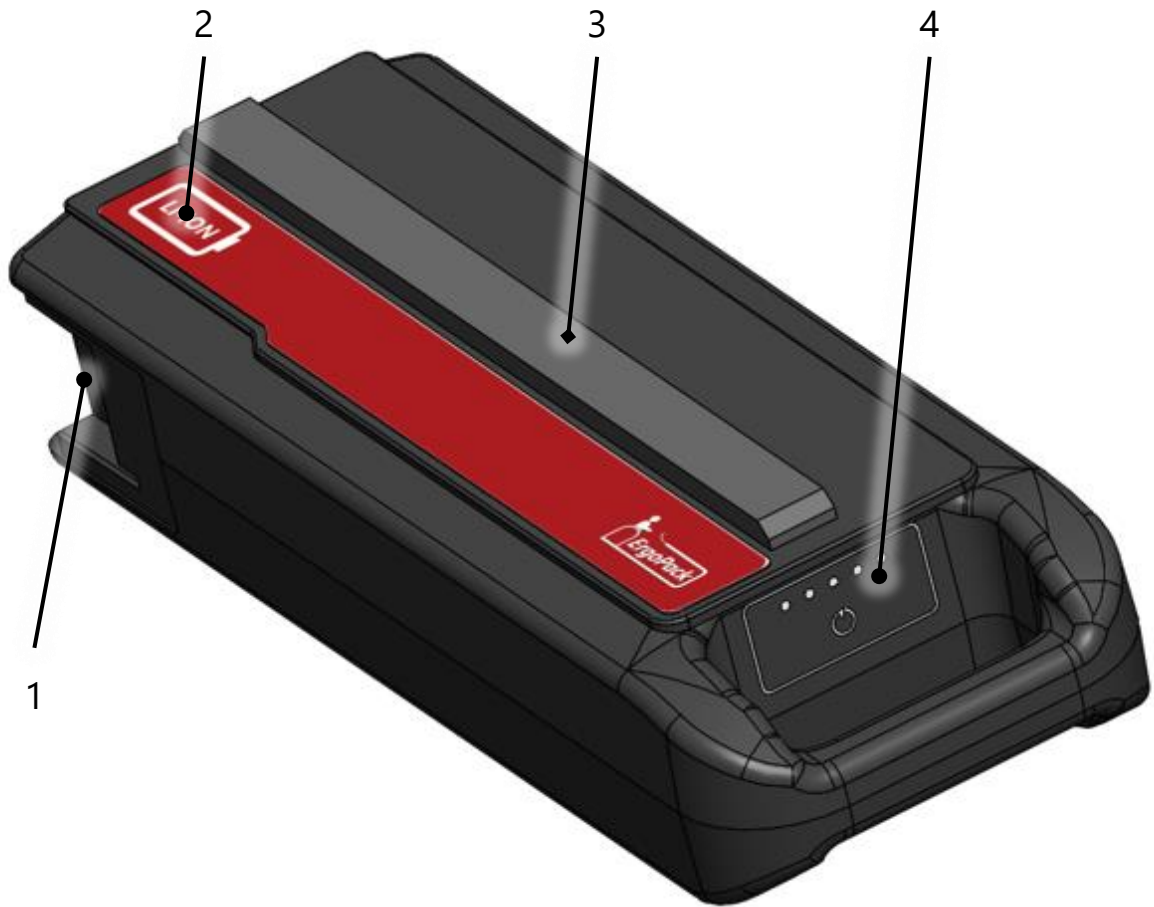

Fig. 10

1. "Charge and discharge socket"
2. "Sticker"
3. "Anti-twist device"
4. "Charge status LED display with on/off button"

4.4.2 LED display Li-ion battery

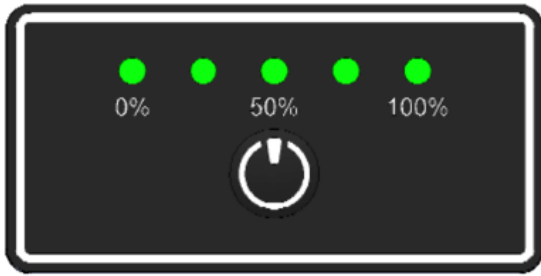

Fig. 11

Charging status LED display
(Display after pressing the on/off button.)

LED 1, 2, 3, 4, 5	State of charge
●●●●●	100...84%
●●●●○	83...68%
●●●○○	67...51%
●●○○○	50...34%
●○○○○	33...16%
★○○○○	15...0% Recharge after two days at the latest to avoid permanent damage
★★★★★	Battery defective. Please contact your ErgoPack service partner

Explanation of symbols LED display

Symbol	Bedeutung
●	LED on
○	LED off
★	LED flashes (50% on, 50% off)

4.5 Indication and commissioning of the Li-ion Battery charging Station/Charger

4.5.1 General view of the Li-ion battery charging station

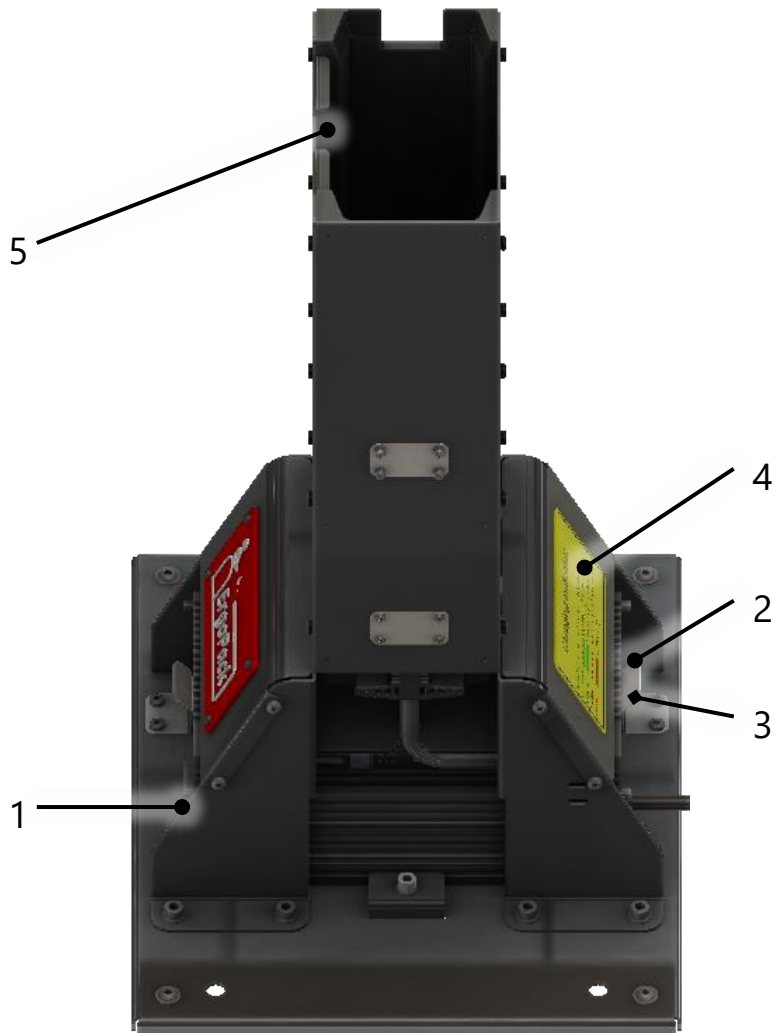

Fig. 12

1. Mains switch
2. LED-Green
3. LED-Red
4. Overview charge level indicator
5. Channel for anti-twist Li-ion battery

4.5.2 General view of Li-ion battery charger

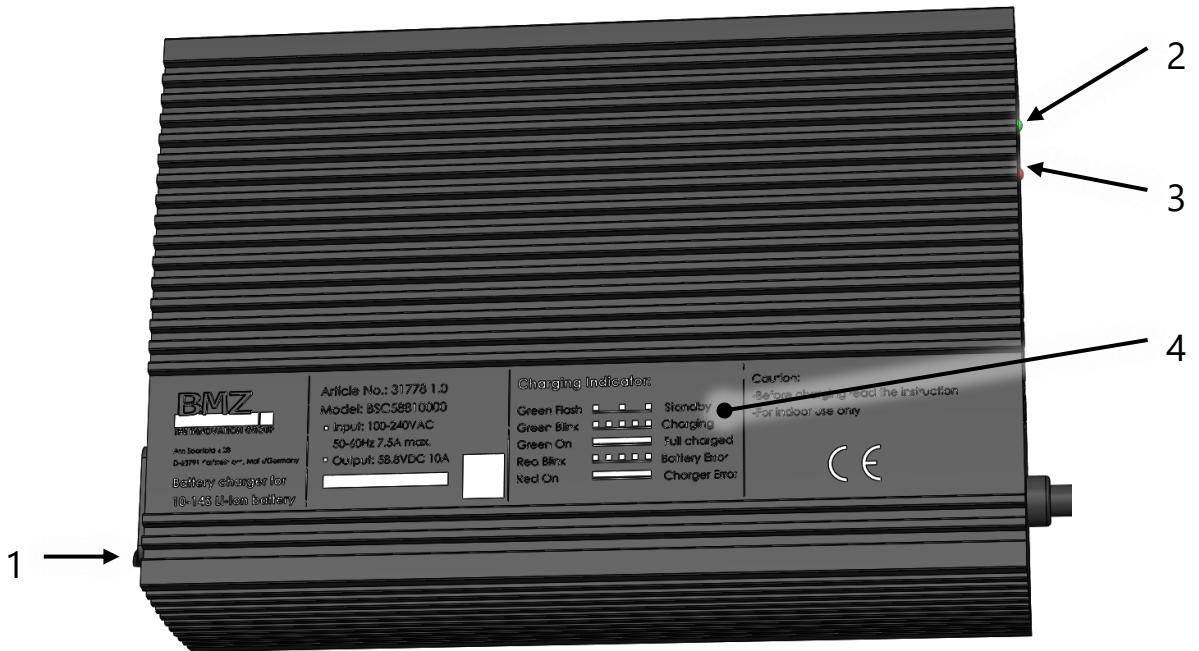

Fig. 13

1. Mains switch
2. LED-Green
3. LED-Red
4. Overview charge level indicator





4.5.3 Commissioning the Li-ion Battery Charging Station/Charger

The ErgoPack Li-ion charging station/charger is used to charge the ErgoPack Li-ion battery is charged.

The green or red LED display on the Li-ion charger shows various operating states of the charger and the charge status of the Li-ion battery.

- 1) Plug the mains cable into the Li-ion charger and the mains socket as far as it will go.
- 2a) Carefully insert the Li-ion battery into the Li-ion charging station (do not let the battery fall into the shaft)!
- 2b) Insert the charging cable into the charging socket of the Li-ion battery as far as it will go.
- 3) Switch on the mains switch on the charger.
 - ⇒ The charging process begins.
- 4) As soon as the battery is fully charged, the charger automatically ends the charging process.
 - ⇒ The LED lights up green.
- 5) Before removing the charged Li-ion battery, switch off the mains switch on the charger.

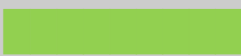
Explanation of symbols LED display

LED	Status
 green	Ready
 green	Battery charges
 green	Battery full
 red	Battery fault
 red	Charger malfunction
off	Not in operation

5. Technical data

5.1 Strapping system

Dimensions (all types)

Length 665 mm
Width 770 mm
Height 1200 mm

Weight (without optional equipment):

ErgoPack RE (incl. Li-ion battery)

approx. 90 kg

Maximum chain speeds:

Slow, strapping

Moving out horizontally: 27 m/min
Moving out vertically: 53 m/min
Moving in vertically: 52 m/min
Moving in horizontally: 39 m/min

Medium, strapping

Moving out horizontally: 29 m/min
Moving out vertically: 58 m/min
Moving in vertically: 57 m/min
Moving in horizontally: 45 m/min

Fast, strapping

Moving out horizontally: 66 m/min
Moving out vertically: 78 m/min
Moving in vertically: 76 m/min
Moving in horizontally: 65 m/min

Belt lifting drive:

Moving out: max. 78 m/min
Moving in: max. 76 m/min

Speed drive winding device

approx. 240 U/min

Max. Chain thrust :

310 N

Measured A-graded

noise emission level

(EN ISO 11202)

RE L_{pA} 79 dB (A)

(EN 60745-1/2:2009)

 L_{pAeq} 77 dB (A)**Sound power level, on average**

(EN 60745 -1/2:2009)

RE LW^{Aeq} 88 dB (A)**Measurement inaccuracy K**

RE 3,0 dB (A)

5.2 Li-ion battery

Typ:	Li-ion batteries
Weight:	approx 5,0 kg
Dimensions:	Length 393 mm Width 153 mm Height 82 mm
Cell interconnection:	10S7P
Voltage (nominal):	36,3 V
Capacity (nominal):	24,15 Ah
Energy:	877 Wh
Discharge current (nominal):	≤ 35 A
Charging current (max.):	14 A
Charging end voltage:	42 V
Operating temperature:	0...40°C

5.3 Li-ion battery – charging station/charger

Typ:	Wide range charger
Weight:	
Charger	1,7 kg
(incl. charging station)	(8,8 kg)
Dimensions:	
Length	225 mm
Width	156 mm
Height	69 mm
Operating voltage:	100...240V 50/60 Hz
Rated power consumption:	up to approx 650 W
Charging current (nominal):	up to approx 10 A
Final charging voltage:	≤58,8 V
Protecting class:	IP20
Operating temperature:	0...40°C

6. Intended use

The strapping system is designed for strapping pallets (machine assisted hand strapping). It has been designed and built for safe and ergonomic operation during strapping.

The strapping system is only suitable for strapping with reusable strapping (Velcro, tensioning strap, etc.).

The strapping system is not designed for strapping open and unpacked food products.

Strapping of flammable products (highly flammable, explosive see table of hazardous substances) is only possible in suitable outer packaging.

The strapping to be used and the tension force when closing the strap must be matched to the packaged goods to be strapped. Constructing the strapping system there was not considered any risk due to damaging of dangerous products or their package.

The strapping system is not designed for strapping in areas with explosive atmospheres (ATEX areas).

Strapping generates electrostatic charges. These can be reduced by a relative humidity of more than 45% and by a conductive or electrostatically dissipative floor (dissipation resistance less than 109 Ω).

The strapping system is not suitable for operation by persons with implants such as pacemakers or defibrillators.

7. Commissioning



Attention!

Before using the strapping system for the first time, a visual inspection for exterior damages has to be done.

7.1 Li-ion battery-charging station/charger

The main voltage must comply with the details on the type plate.
The Li-ion battery charging station / charger is only suitable for charging the supplied original ErgoPack Li-ion battery, article number EP103110.

7.2 Charging the Li-ion battery

- 1.) Connect charger to the main voltage
- 2.) Open cover of Li-ion battery case (by pulling at the outer corners as shown below).



Fig. 14

3.) Remove the Li-ion battery from the strapping system by pulling it out.

4a.) When using the Li-ion Charging station, the Li-ion Battery into the Li-ion charging Station to load up to the stop gently into place. Then close Power switch on the Li-ion Set the charger to "I".

4b.) When charging without a Li-ion charging station, insert the charging cable the charging cable into the socket of the Li-ion battery. Then press the mains switch on the Li-ion charger to "I".

5.) Before removing the charged Li-ion battery, switch off the mains switch on the charger.

6.) Carefully insert the charged Li-ion battery into the battery compartment as far as the into the battery compartment as far as it will go.

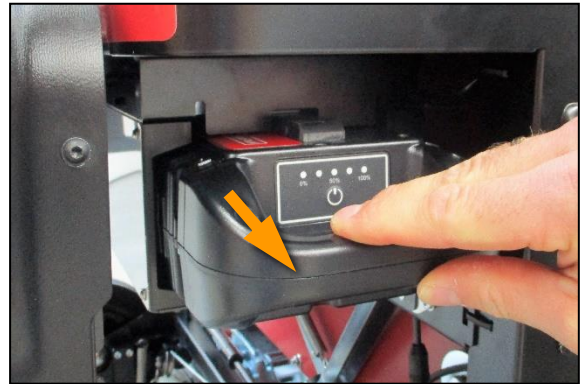

Fig. 15



Fig. 16



Fig. 17



Fig. 18



Attention!

When inserting the Li-ion battery into the strapping system, the anti-twist device must point upwards!



Warning!

Damaged Li-ion batteries can burn or explode.

- ▶ Never use dropped or damaged Li-ion batteries.
- ▶ Store dropped Li-ion batteries in a non-flammable container.
- ▶ Send dropped Li-ion batteries to your ErgoPack service partner. For shipping, see chapter 2.7.



Attention!

The charging time is approx. 3 hours. The Li-ion battery is only fully charged when all 5 LEDs on the Li-ion battery light up green continuously!

The Li-ion battery and the Li-ion charger should be supervised during the charging process.

Do not charge an overheated Li-ion battery. The charging process must be interrupted if the Li-ion battery heats up too much ($>60^{\circ}\text{C}$). The Li-ion battery must be cooled down to ambient temperature before further charging. If there is a smell or smoke or if the Li-ion battery is too hot to touch, the charging process must be interrupted immediately and the ErgoPack service partner informed.



Note!

If the Li-ion battery is stored (not used) for a longer period of time, this should be done with a charge level of approx. 50% and, if necessary, recharged approx. every 3 months.

7.3 Switching on the strapping system

Instructions:

- Charge the Li-ion battery pack as described under 7.2.
- Carefully push the Li-ion battery into the battery compartment of the strapping system as far as it will go. Observe the installation position of the anti-twist device.
- Close the cover of the Li-ion battery case.
- Make sure that the EMERGENCY STOP switch (20a) is not pressed. If necessary, unlock it by turning.
- Turn the main switch (20d) to the right to operating mode "1" and hold it in this position for approximately 2 seconds.



Fig. 19



Fig. 20

20a

20b

20c

20d

- Follow the instructions on the display after the "ErgoPack" logo disappeared (after approx. 45 seconds).

7.4 Setting the date and time



Attention!

The date and time may only be set by trained, instructed personnel. You can obtain the required access code from your ErgoPack service partner.

Step 1

Check the time in the display in the main menu at the top left.

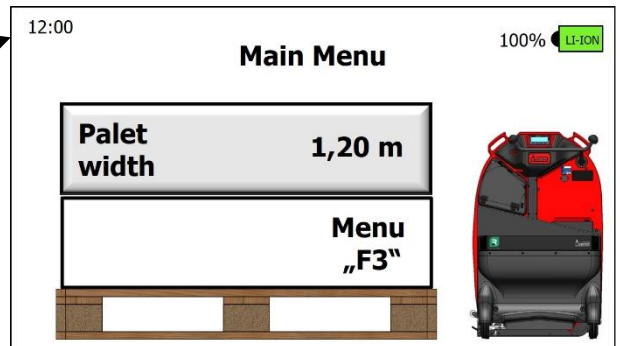

Fig. 21

Step 2

Press the "F3" button (1) on the display and press repeatedly on "Continue" (2) until menu page 8 (3) appears.

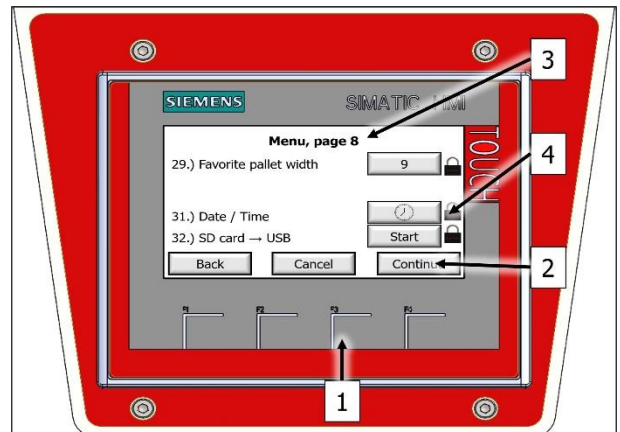

Fig. 22

Step 3

Press the "Clock" button (4) in menu line 31.).

Step 4

Unlock the lock with the corresponding access code.

Step 5

Check the date.

Year, month and day can each be set with the "+/-" button.

Then confirm the set date with the "Store" button.

If the date does not need to be set, you can switch to setting the time by pressing the "Store" button.

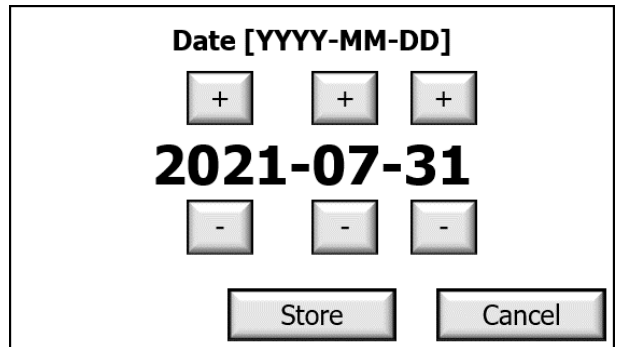

Fig. 23

Step 6

Check the time.

Hour and minute can each be set with the "+/-" button.

Then confirm the time with the "Store" button.

If the time does not need to be set, the date/time setting can be saved by pressing the "Store" button.

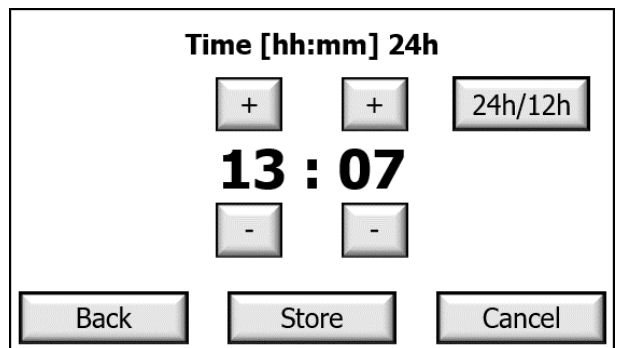

Fig. 24

Press the "24h/12h" button to switch between 24-hour or 12-hour format.

7.5 Setting pallet width

Step 1

To set the correct pallet width, press the „Pallet width“ button in the main menu.

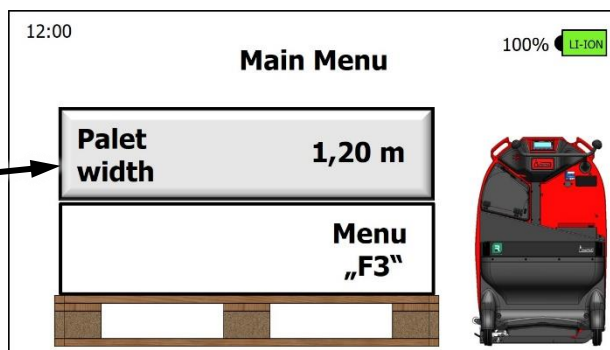

Fig. 25

Step 2

You can choose the required width of the pallet to be strapped among the factory set pallet widths.

In case the required pallet width is not listed, you can adjust one of these buttons to the required pallet width.



Fig. 26

For changing one of the buttons to the required pallet width, proceed as follows:

Press and hold the button to be changed for approx. 3 seconds. You can then set the required pallet width in 10 cm steps (Fig. 27). As soon as you confirm your setting with „OK“, this new pallet width will be saved in the preset pallet widths.

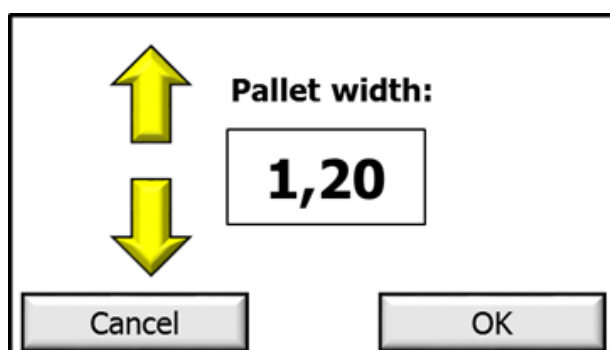

Fig. 27

Your ErgoPack is now ready for strapping.

8. Operation



Note!

Strapping and winding is possible with different, reusable straps/belts. Two variants are shown as examples in points 8.1 to 8.4.

8.1 Strapping with Velcro tape



Fig. 28

Step 1

Place the ErgoPack at a distance of approx. 40 cm (D) in front of the pallet to be strapped.

If your system is equipped with the optional line laser:

Align the ErgoPack parallel to the pallet so that the laser line runs alongside the pallet edge.



Fig. 29

Step 2

Move out the ChainLance by pushing the joystick in „move out“ direction.

The reversing sledge leads the strap through and underneath the pallet...



... and back up again on the opposite side.

Fig. 30



If the setting of the pallet width and the positioning of the strapping system are correct, the distance between the chain and the pallet is about 10 cm.

Fig. 31



Attention!

Push the joystick until the ChainLance appears on the other side and falls in your direction.

Release the joystick, so that it returns to the neutral position (central position) and stops the ChainLance moving out further.

Catch the ChainLance as shown at the red head piece. Do not let the ChainLance drop onto the package!

Step 3

Open the winding device and insert the Velcro tape.

Attention:

The fork must be folded down. To do this, pull the fork straight out as far as it will go (Fig. 33) and fold it down towards the base plate (Fig. 33a).



Fig. 32

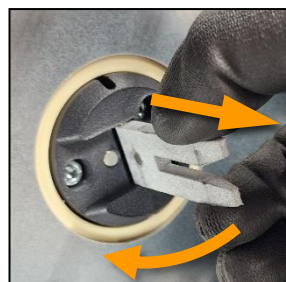

Fig. 33

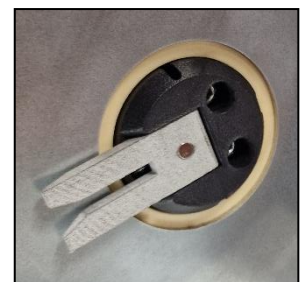

Fig. 33a

Attention:

The tongue must be outside the winding device.

Step 4

Close the winding device again.



Fig. 34

Step 5

Insert the tongue into the headpiece.



Fig. 35



Fig. 35a



Fig. 36

Step 6

Move the ChainLance all the way back by pressing the joystick in the "Retract" direction until the ChainLance stops again between the ErgoPack and the packaged goods at the height of the winding device and moves back minimally to relieve the strain on the strapping.



Fig. 37

Step 7

Hold the Velcro tape at the upper end with your right hand and press the red actuator in the head piece with your left hand so that the tongue is released and can be removed.



Fig. 38

Step 8

Remove the metal eyelet from the winding device

Step 9

Guide the start of the Velcro tape through the metal eyelet (Fig. 39) and stretch the Velcro tape to the required tension (Fig. 39a).

At the end, fix the start of the strap together with the tongue over the Velcro at the end of the strap (Fig. 39b).



Fig. 39



Fig. 39a



Fig. 39b

Step 10

Move the ChainLance all the way back by pressing the joystick in the "Retract" direction until the ChainLance and the reversing sledge are back in the strapping system.



Fig. 40

8.2 Wind up Velcro tape

Step 1

Open the cover of the winding device.



Fig. 41

Step 2

Move the fork upwards.

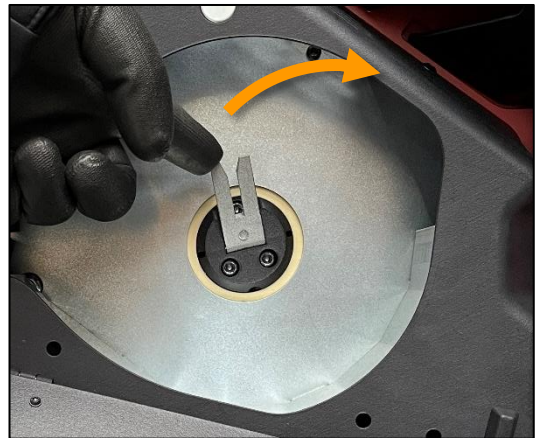

Fig. 42

Step 3

Insert the end of the tape into the winding device with the metal eyelet first and insert the piece of tape into the fork just after the eyelet.

Attention:

The fluffy side of the Velcro tape must face upwards.



Fig. 43

Step 4

Close the winding device and press and hold the red button until the Velcro tape is fully wound up.



Fig. 44

Attention:

Make sure that the Velcro tape does not become knotted in front of the winding device, otherwise the winding device may be damaged.

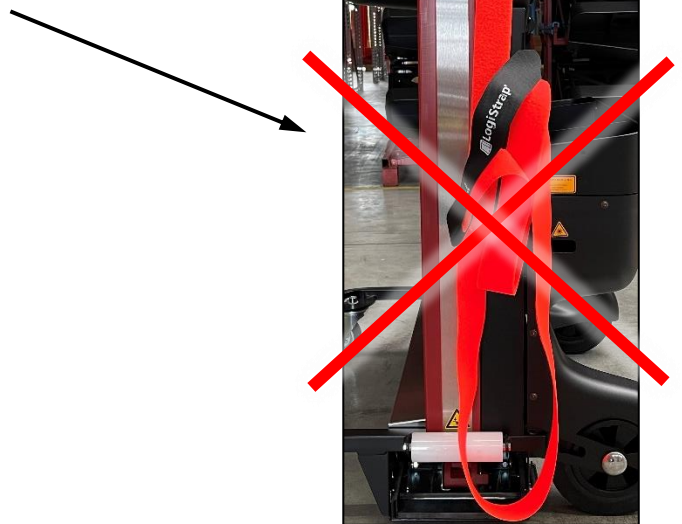

Fig. 44a

Step 5

Open the winding device (Fig. 41) and remove the wound-up Velcro tape from the winding device.



Fig. 45

8.3 Strapping with tension belt

Step 1

Perform steps 1 to 2 listed under point 8.1 and then continue with step 2.

Step 2

Open the cover of the winding device and insert the tension belt.



Fig. 46

Step 3

Close the winding device again.

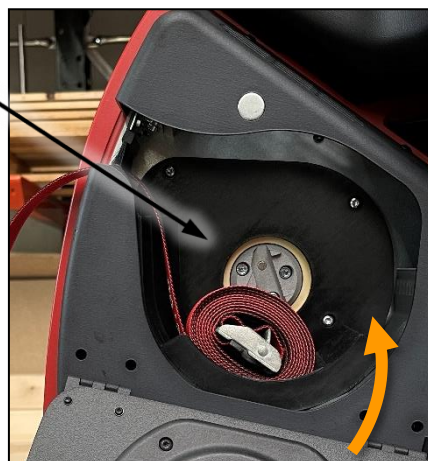

Fig. 47

Step 4

Insert the start of the strap into the head piece until it is visible in the slot.



Fig. 48

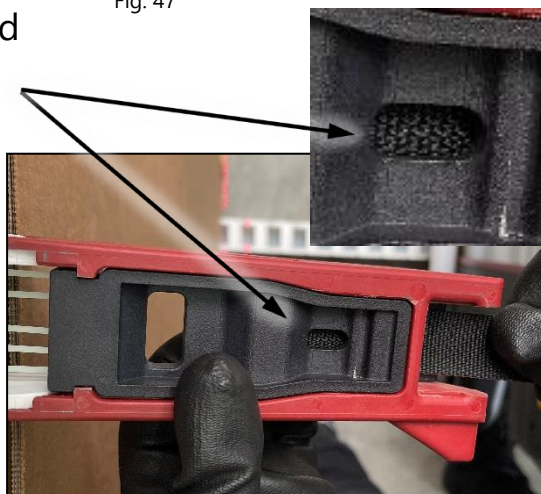

Fig. 48a

Step 5

Move the ChainLance all the way back by pressing the joystick in the "Retract" direction until the ChainLance stops again between the ErgoPack and the packaged goods at the height of the winding device and moves back minimally to relieve the strain on the strapping.

Step 6

Hold the tension belt at the upper end with your right hand and press the red actuator in the head piece with your left hand so that the tension belt is released and can be removed.



Fig. 49

Step 7

Remove the clamping lock from the winding device.

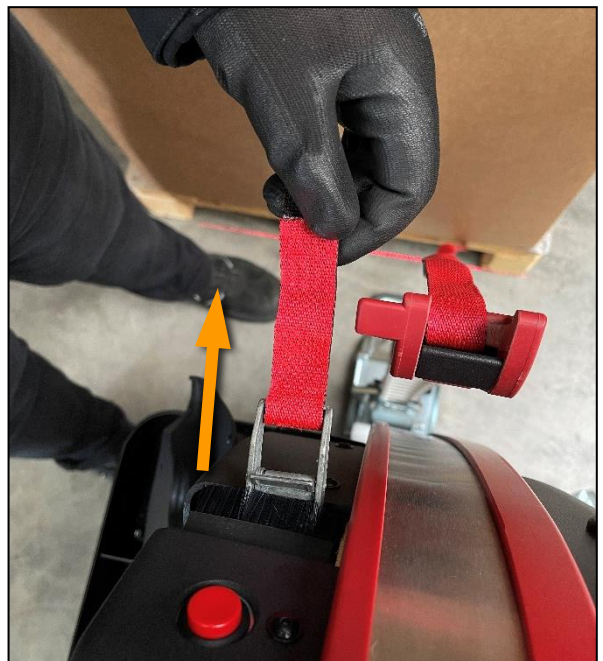

Fig. 50

Step 8

Guide the beginning of the tension belt into the clamping lock (Fig. 51) and lash the belt to the required tension (Fig. 51a).



Fig. 51

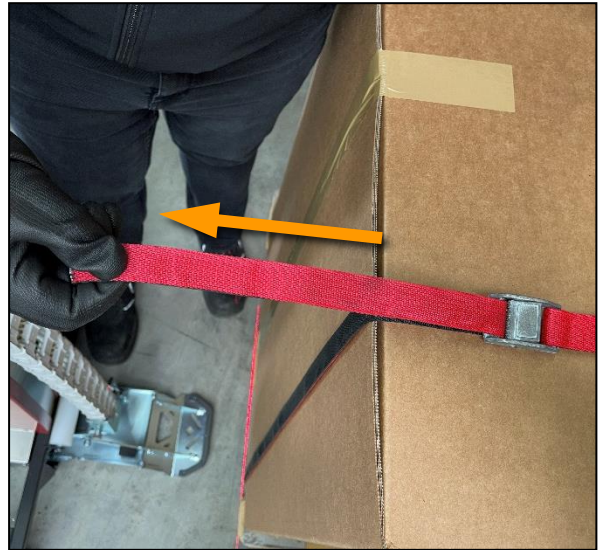

Fig. 51a

Step 9

Move the ChainLance all the way back by pressing the joystick in the "Retract" direction until the ChainLance and the reversing sledge are back in the strapping system.



Fig. 52

8.4 Wind up tension belt

Step 1

Open the cover of the winding device.

Step 2

Insert the end of the strap into the winding device with the clamp lock first.

Attention:

Please ensure the correct alignment of the clamp lock. (Fig. 59 and Fig. 59a as examples).

Step 3

Press the actuator down and place the clamp lock in the holder. Release the actuator so that the clamp lock clamps into the holder.



Fig. 53

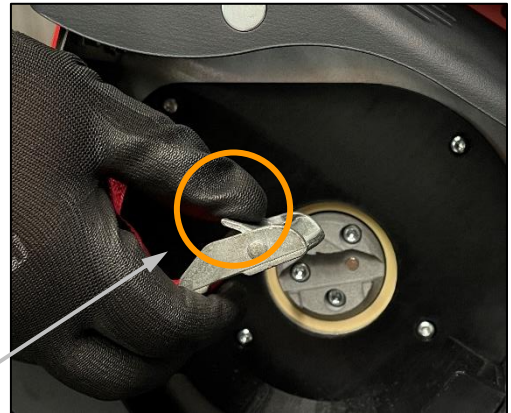

Fig. 54

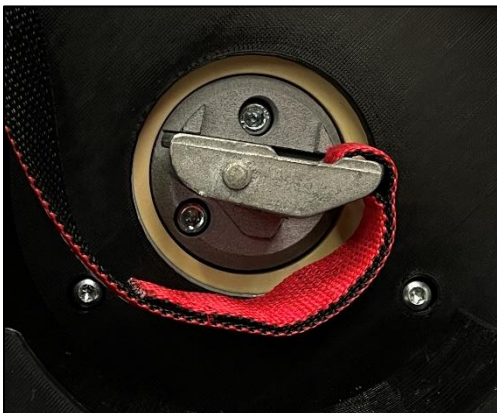

Fig. 59a

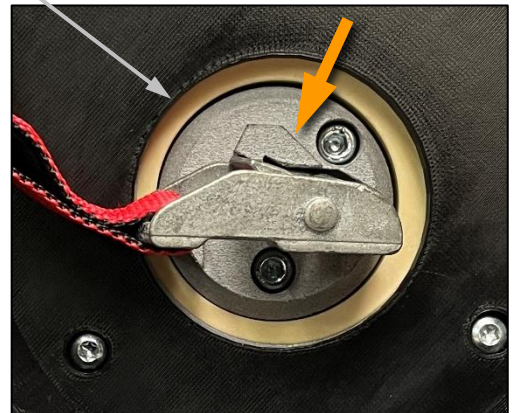

Fig. 59

Step 4

Close the winding device and press and hold the red button until the tension belt is fully wound up.

Attention:

Ensure that the tensioning belt does not become knotted (Fig. 57a) or twisted (Fig. 57) in front of the winding device, as otherwise the winding device may be damaged or the belt may not be wound up properly.

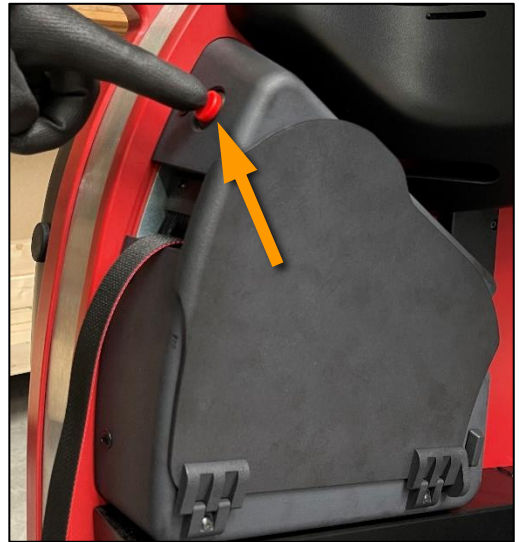

Fig. 56



Fig. 57a



Fig. 57

Step 5

Open the winding device (Fig. 53) and remove the wound tension belt from the winding device.



Fig. 58

9. Risks



Attention: Laser beam!

Direct eye contact with the laser beam or reflecting radiation may result in permanent eye injuries.

Never look direct in the laser.

Laser category 2
DIN EN 60825-1:2015-07

Power: 10 mW
Wavelength: 635 nm



Warning:

Strap tensioning or strapping, danger of jamming and crushing.

Do not place hands or other body parts between the strap and the packaged goods during the strapping process.

Ensure that there are no other persons in the hazardous zone.

For an emergency stop in case of danger (trapped person):

- After sealing, cut the tape. If necessary, cut with a tool (strap cutter).
-



Warning:

The following hazards can result in serious injury or death.

Explosion hazard in EX zones

The strapping system must not be used in areas where an explosive atmosphere may occur.

Risk of explosion or fire if Li-ion battery is damaged

Damaged batteries can burn or explode. Never use dropped or damaged batteries.

Electric shock

Strapping creates electrostatic charges. These can discharge via the user. The strapping system is therefore not suitable for operation by persons with implants such as pacemakers or defibrillators.



Warning!

Following hazards can result in serious injuries:

Chain lance, risk of injury

When the ChainLance moves upwards on the opposite side of the pallet, its own weight causes it to fall over the pallet towards the operator. **If you are not careful, the ChainLance can fall on the operator's head and cause injuries.** Always be alert and concentrated and catch the ChainLance if it falls over the pallet.

Incorrectly welded strapping cannot secure the load and can therefore lead to injuries.

Never transport or move a packaged good with an incorrectly executed weld.

A damaged strap cannot secure the load and can therefore lead to injuries.

Never transport or move packaged goods with a damaged strap.

ChainLance, risk of tripping

When parking the strapping system, the ChainLance must be fully inside it. The reversing sledge must not stick out.

Loose tapes, risk of tripping

It must be ensured that unused straps are immediately removed from the floor and in the area of the packaged goods.

ChainLance, risk of crushing

Do not put your fingers into the area of the tension wheel of the sealing head and into the ChainLance.

Reversing sledge, risk of crushing

Especially around the entire surroundings of the reversing sledge, there is a risk of squeezing.



Warning!

Following hazards can result in serious injuries:

Hazardous area, risk of crushing and risk of injury

Make sure before each strapping cycle, that there is no person in the hazardous area (especially of the ChainLance) and nobody can enter that area. This is due, especially for the limited or bad visible area on the opposite site of the pallet (operators view). During strapping, there must not be any hands or other body parts between strap and goods.

Power source, risk of injury

Before maintenance or repair works:

Switch off the strapping system by pressing the „OFF“ switch, the key has to be removed from the main switch and the Li-ion battery from the strapping system.

Hazardous area winding device, risk of injury

Before each strapping and winding process, make sure that the winding device is closed. No hands or other parts of the body may be in the winding device during the winding and unwinding process.



Caution!

Following hazards can result in minor or moderate injuries:

Tilting danger

Strapping pallets should, whenever possible, take place in areas with an even surface. When using the strapping system on inclined surfaces, after positioning and before strapping, the brakes of the castor wheels on the strap side have to be locked.



Attention!

Avoid damages on the strapping system:

Water damages

For cleaning of the strapping system do not use water or steam.

Visual inspection

Before using the strapping system for the first time, a visual inspection for external damage has to be done.

Use only original ErgoPack spare parts!

Warranty and liability become invalid if other than ErgoPack spare parts are used.

9.1 Emergency information

9.1.1 First aid measures

Symptoms caused by combustion gases or leaking fluids require medical attention.

After inhalation

Leave the area immediately. Move to fresh air. Consult a doctor.

After skin contact

Remove solid particles immediately. Rinse affected areas with plenty of water for at least 15 minutes. Then gently dab the affected skin area, do not rub dry. Remove contaminated clothing immediately. In case of redness or abnormalities, consult a doctor.

After eye contact

Rinse eyes cautiously with plenty of water for at least 15 minutes. Protect unaffected eye. Consult a doctor.

After ingestion

Drink plenty of milk or water and induce vomiting. Consult a doctor.

9.1.2 Fire fighting measures



Warning!

Inhalation of vapours may cause poisoning.

- ▶ Place on the side of the fire from which the wind comes
 - ▶ Use respiratory protection if possible.
1. If possible, carefully remove the Li-ion battery from the strapping system.
 2. Evacuate all persons from the immediate fire area.
 3. Use plenty of water or fire extinguishers of fire class D to fight the fire.
 4. Alert the fire brigade if the fire cannot be fought by yourself or gets out of control.

10. Service and repair

Your ErgoPack is made out of galvanized steel, powder coated steel, stainless steel and highly wear resistant plastic and is basically maintenance free.

Clean the outside of the ErgoPack with a damp cloth if it is extremely dirty.



Warning!

During all maintenance and service/repair works, the strapping system has to be switched off by pressing the „OFF“ switch, the key has to be removed from the main switch and the Li-ion battery removed from the strapping system.

10.1 Cleaning the ChainLance

Clean the ChainLance with acetone or petroleum if it has become dirty with oil. Always wear appropriate protective equipment.



Attention!

Do not place the ChainLance into cleaner.
Never use lubricants like grease or oil!

10.2 Replacing the ChainLance

Step 1

(There are 2 options)

Option 1

Set the pallet width at the display of the strapping system to 1m and drive out the ChainLance until the joint of the reversing sledge folds up and locks into this position.



Fig. 59

Afterwards, switch off the strapping system by pressing the OFF button and remove the Li-ion battery from the strapping system. For this purpose, the cover of the Li-ion battery compartment has to be opened (by pulling at the wheel covers). (Fig. 60)

Option 2

Switch off the strapping system by pressing the OFF button and remove the Li-ion battery from the strapping system. For this purpose, the cover of the Li-ion battery compartment has to be opened (by pulling at the wheel covers). (Fig. 60)



Fig. 60

A second person presses downwards the „rocker“ of the locking unit (Fig. 61), which is connected with the magnet lock through the folding spring bolt. At the same time the other person pulls the reversing sledge out of the strapping system (Fig. 62).



Fig. 61

Now, pull out the reversing sledge by about 1 m and fold up the joint. (Fig. 63)



Fig. 62

Step 2

Pull the ChainLance out of the strapping system as shown and roll it up.

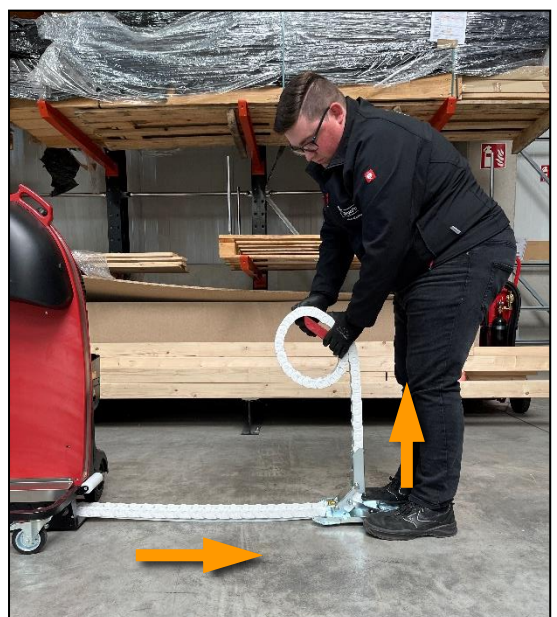

Fig. 63

Step 3

Push the new ChainLance in again in reversed order of the removal.



Fig. 64

By pushing the end piece of the ChainLance into the system, the end pieces preloaded by a spring (Fig.65), has to be aligned straight (Fig. 66). Press the chain links down with your finger and push them into the strapping system ...

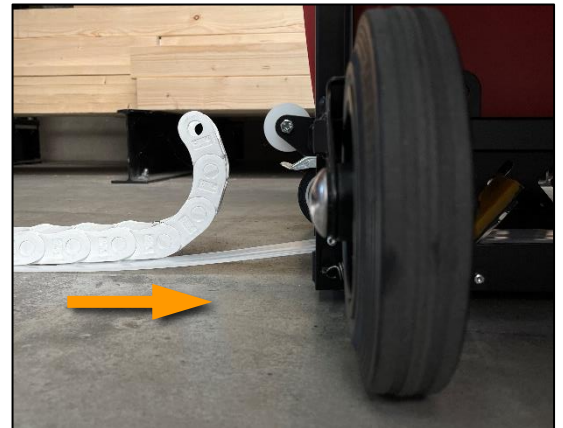

Fig. 65

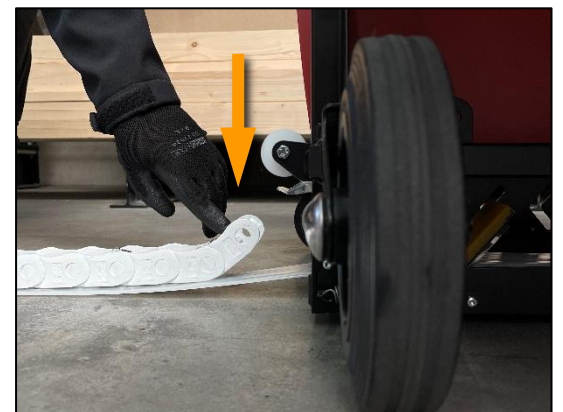

Fig. 66

... so that the end of the ChainLance can be inserted into the groove of the ChainLance (Fig. 67) in the central part of the strapping system (Fig. 68).



Fig. 67

Groove of the ChainLance



Fig. 68

Also for that, the preloaded chain links have to be pressed down with your finger (Fig. 69).



Fig. 69

Step 4

Put the strapping system into operation in accordance with section 7.

10.3 Replace stiffened chain section (2m) incl. head piece

Step 1

Set the pallet width of the strapping system to 0.60 m and extend the ChainLance ...



Fig. 70

... and place the first 2 metres of chain on the strapping system. Then switch off the strapping system with the OFF button and remove the Li-ion battery from the strapping system.



Fig. 71

Step 2

Push a screwdriver (blade width 5,5 mm) between the legs of the last reinforced link and the next link from the underside ...



Fig. 72

... and slew the chain to the side by turning the screwdriver carefully ...

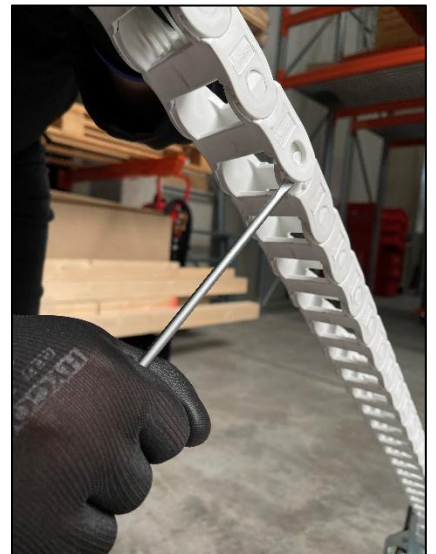

Fig. 73

... until the two chain links fully separate.

Step 3

The chain, which is reinforced with glass fibre rods, is installed in reverse order of removal.

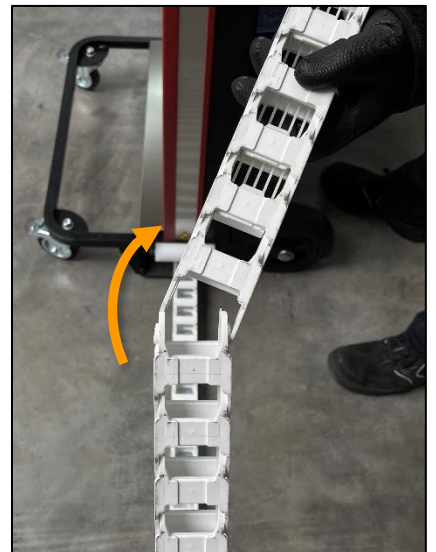

Fig. 74

10.4 Replacing the reversing sledge

Step 1

Remove the first 2 metres of the ChainLance as described in point 10.3.

Step 2

Push the ChainLance manually back into the strapping system until the ChainLance has completely moved out of the reversing sledge.



Fig. 75

Step 3

Place the reversing sledge on its top as illustrated and use a screwdriver to unscrew both screws of the length adjusting belt.

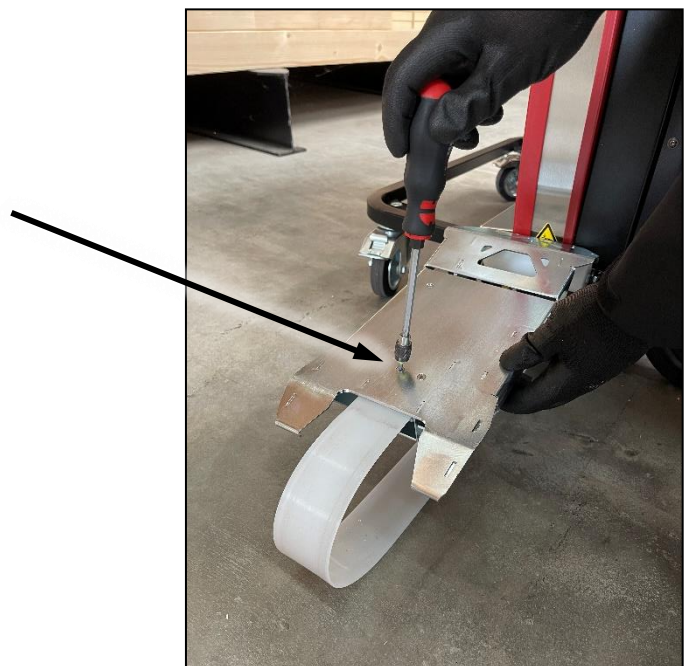

Fig. 76

Step 4

The fitting of the reversing sledge is done in the reversed order of the dismantling.



Achtung!

Die beiden Schrauben des Längenbegrenzungsbandes müssen mit „Schraubensicherung mittelfest“ gesichert werden!

10.5 Replacing individual chain links

In case of broken individual chain links, the ChainLance can be opened as described under point 10.3 to replace those defective chain links.

It is temporarily also possible to remove a defective chain link without the need to insert a new chain link.



Attention!

After removing the chain link, the strapping system has to be restarted. After each restart, the control unit automatically adjusts to the correct zero position in accordance with point 7.3.



Note!

As the new shorter chain length is unknown to the control unit, it may happen that when driving out the chain completely, the end of the chain will not be recognized correctly any longer and the ChainLance will be pushed out over the driving gearwheel.

This can cause a malfunction. Therefore, missing chain links should be replaced as soon as possible.



Note!

No individual chain link can be replaced in the first 2 metres. The entire chain section (2m) must be replaced in accordance with point 10.3.

10.6 Replacing the length adjusting belt

Step 1 (dismantling)

Perform steps 1 to 3 listed in point 10.4 and continue with step 2.

Step 2

Open the cover „Li-ion battery compartment“ as described under point 7.2 „charging the Li-ion battery“.

Now, unlock the ball lock pin by pressing the release button and pull it out of the storage plate.

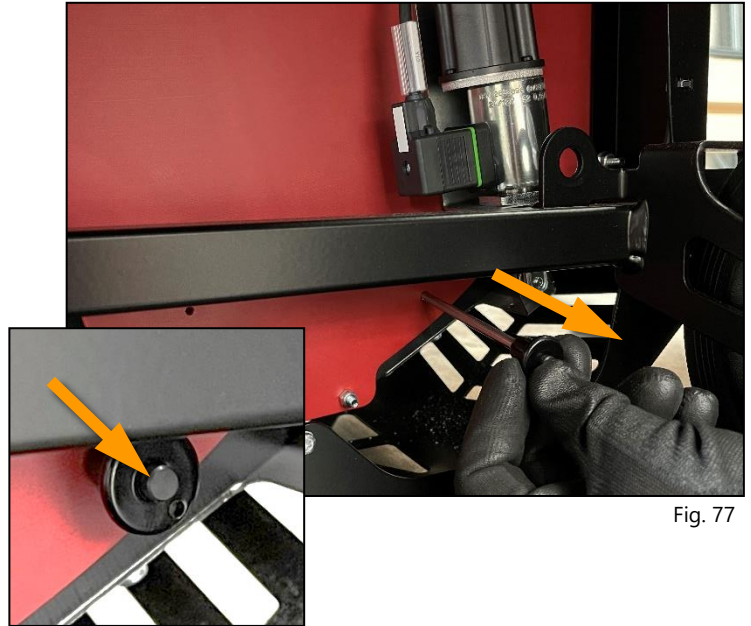

Fig. 77

Step 3

A second person presses downwards the „rocker“ of the locking unit which is connected with the magnet lock through the folding spring bolt. At the same time the other person pulls the length adjusting belt out of the strapping system.



Fig. 78

Step 4 (installation)

Push the ChainLance all the way back into the strapping system so that you can see the groove of the length adjusting belt.

Step 5

Push the new length adjusting belt into the small groove below the groove for the ChainLance.



Fig. 79



Attention!

Make sure that the length adjusting belt is inserted into the lower groove and that it does not slide into the upper groove of the ChainLance.

Step 6

The further installation is done in the reversed order of the dismantling.

10.7 Replace the fork of the winding device

Step 1

Open the cover of the winding device.



Fig. 80

Step 2

Move the fork upwards and loosen the 3 screws

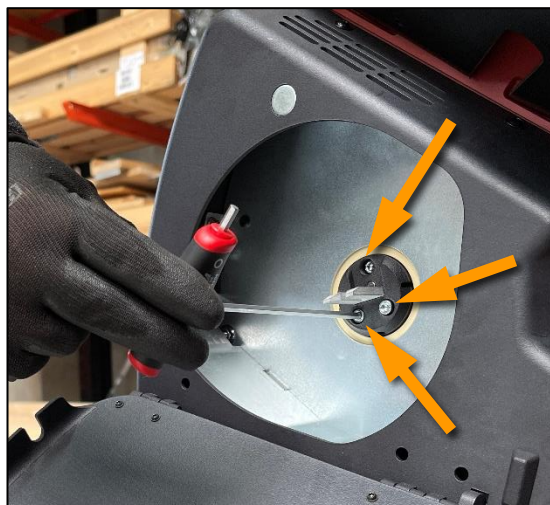

Fig. 81

Step 3

Remove the tape holder.



Fig. 82

Step 4

The tape holder is installed in reverse order of removal.

10.8 Replace the clamping lock of the winding device

Step 1

Open the cover of the winding device.



Fig. 83

Step 2

Loosen the 3 screws.

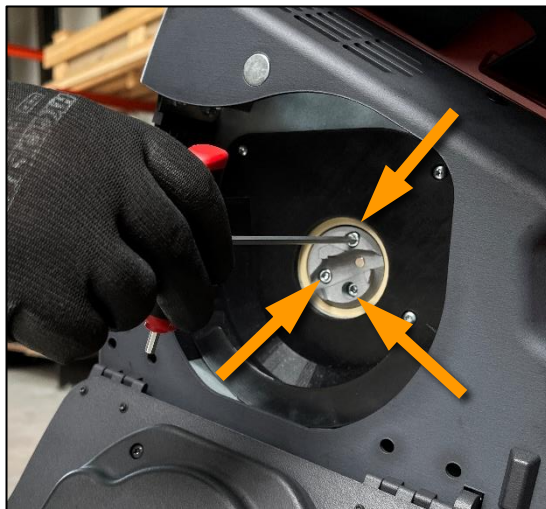

Fig. 84

Step 3

Remove the clamp lock holder.



Fig. 85

Step 4

The clamp lock holder is installed in reverse order of removal.

10.9 Changing the control box joystick unit



Warning!

Improper handling of the electronic components can lead to defect or malfunction of the strapping system.

1. To prevent voltage flashover to electronic components during maintenance work, the person carrying out the maintenance must discharge himself (e.g. by touching a water pipe).
2. Observe the assembly and disassembly sequence in order to be able to safely discharge electrostatic charges.

Step 1

Remove the cover „joystick“ by pulling on the handle holes, provided at the bottom side (the cover is fixed by magnets).



Fig. 86

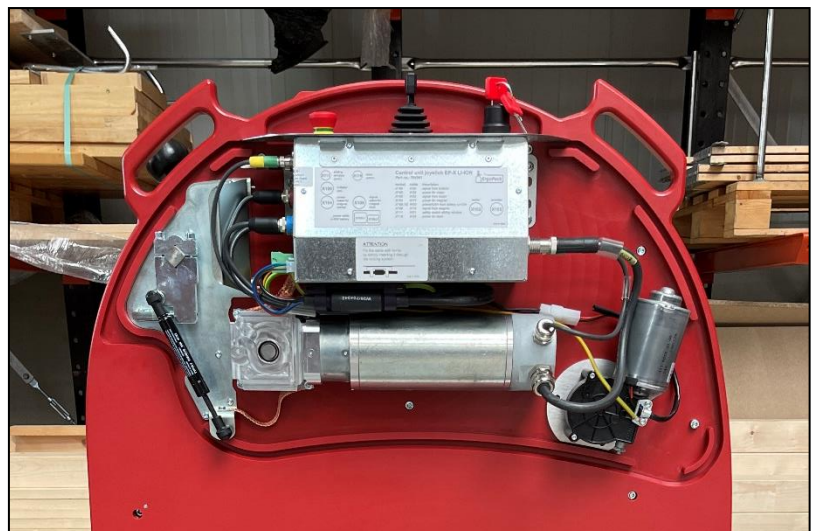

Fig. 87

Step 2

First disconnect the plugs of the power cable, then the two motor cables on the opposite side and then all other plugs.

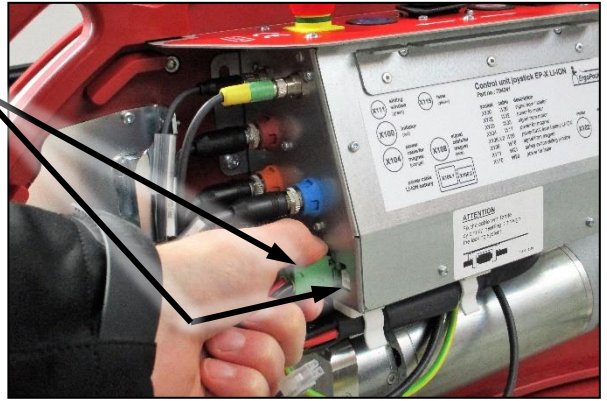

Fig. 88



Attention!

The plugs are secured with a screw socket which has to be unlocked by turning it counter clockwise. Remove the plugs afterwards only.

Step 3

Unclip the power cable from its holder on the underside of the control unit.

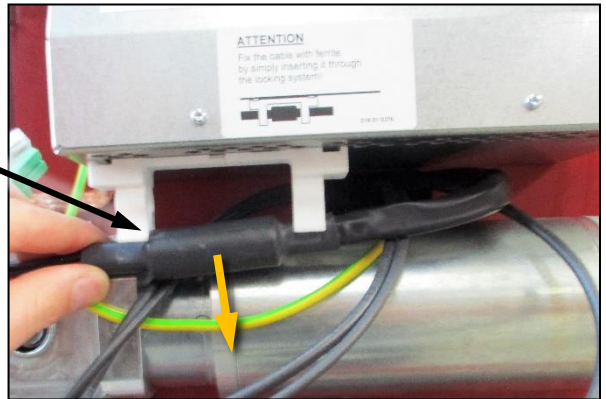

Fig. 89

Step 4

Remove the 4 screws on the side of the control unit.

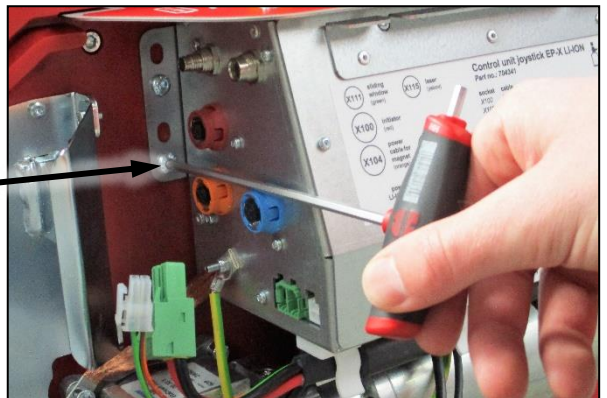

Fig. 90

Step 5

Now carefully loosen the plug connections on the back of the control unit.



Attention!

Disconnect the earth cable (green-yellow) last.



Attention!

For disconnecting the plug of the black/red cable, you have to pull the flap of the plug.

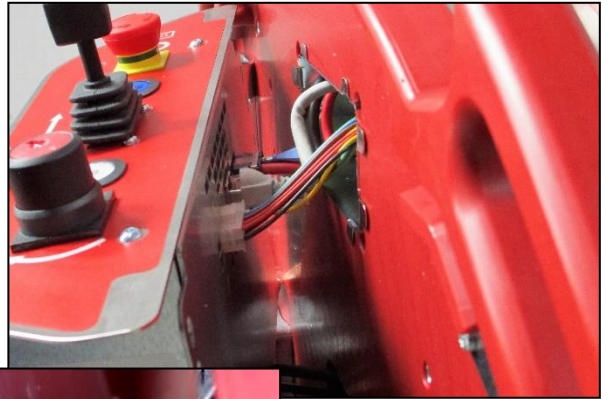
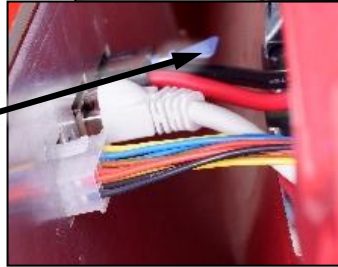

Fig. 91



Step 6

Remove the nut on the ground bolt/threaded stud and then pull off the ground cable and ground strap.

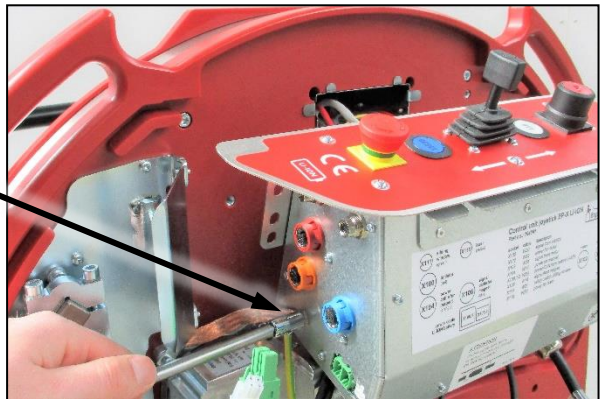

Fig. 92

Step 7

The installation of the control unit is done in the reversed order of the disassembling. While connecting the cables always take note of the information on the label (93a) located on the front side of the control unit.

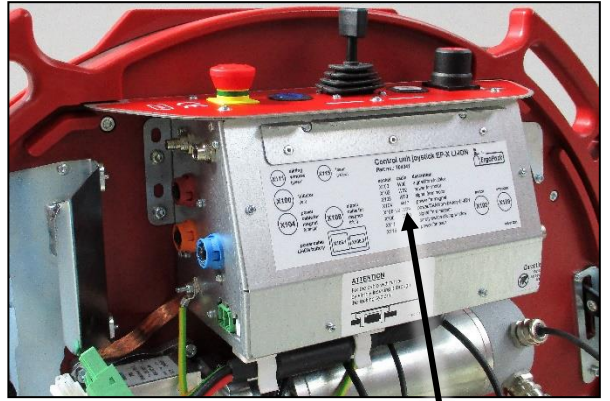

Fig. 93

93a



Attention!

The plug-in connection is positioned relative to one another through a plastic nose and groove. When having the correct position, connect the plug and secure it by the screw socket. This screw socket has to be closed by turning it clockwise. Only then, the function of the plug-in connection is ensured.

10.10 Changing the control box display unit



Warning!

Improper handling of the electronic components can lead to defect or malfunction of the strapping system.

1. To prevent voltage flashover to electronic components during maintenance work, the person carrying out the maintenance must discharge himself (e.g. by touching a water pipe).
2. Observe the assembly and disassembly sequence in order to be able to safely discharge electrostatic charges.

Step 1

At first, remove the control box joystick unit as described in section 10.9.

Step 2

Fold the Easy-Move-Assistant upwards and open the cover of the winding device.

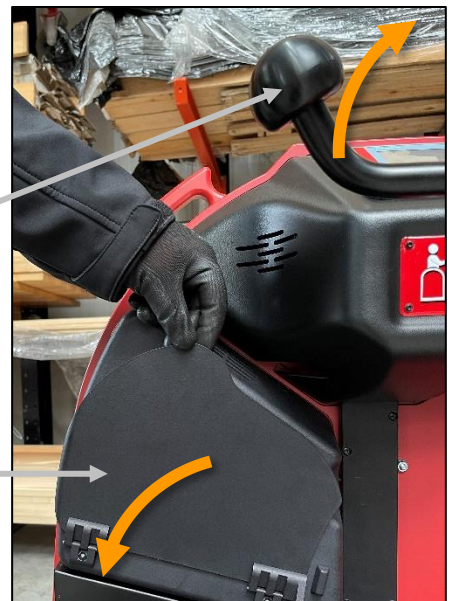

Fig. 94

Step 3

Remove the cover „display“ by pulling on the provided handle holes diagonally downwards. (The cover is fixed by magnets).

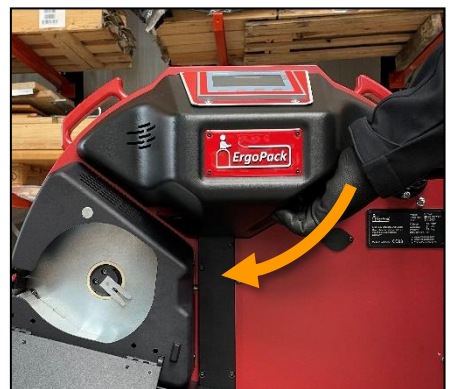

Fig. 95

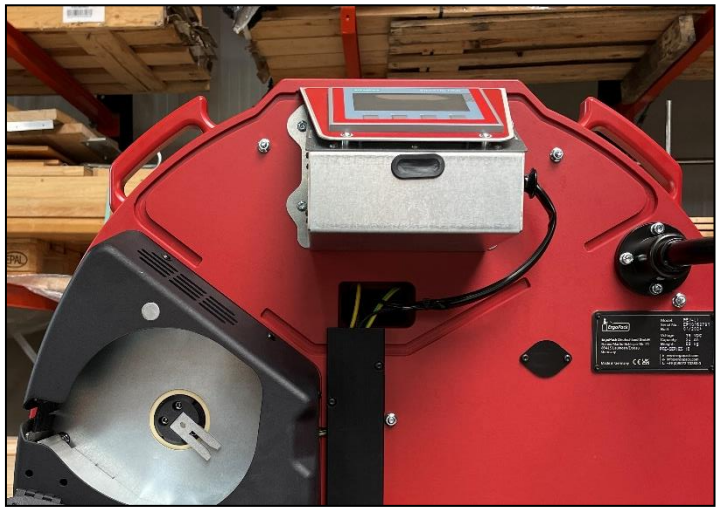

Fig. 96

Step 4

Remove the 4 screws on the side of the control unit and...



Fig. 97

... remove the control box and thereby pull the cable carefully through the cable duct.

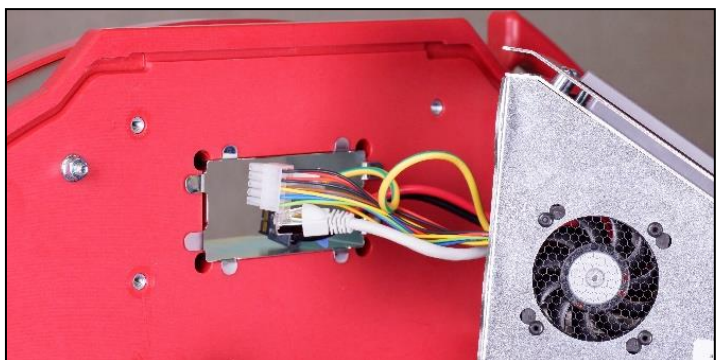

Fig. 98

Step 5

The installation of the control unit is done in the reversed order of the disassembling.

10.11 Changing the motor



Warning!

Improper handling of the electronic components can lead to defect or malfunction of the strapping system.

1. To prevent voltage flashover to electronic components during maintenance work, the person carrying out the maintenance must discharge himself (e.g. by touching a water pipe).
2. Observe the assembly and disassembly sequence in order to be able to safely discharge electrostatic charges.

Step 1

Remove the cover „joystick“ by pulling on the handle holes, provided at the bottom side (the cover is fixed by magnets).



Fig. 99

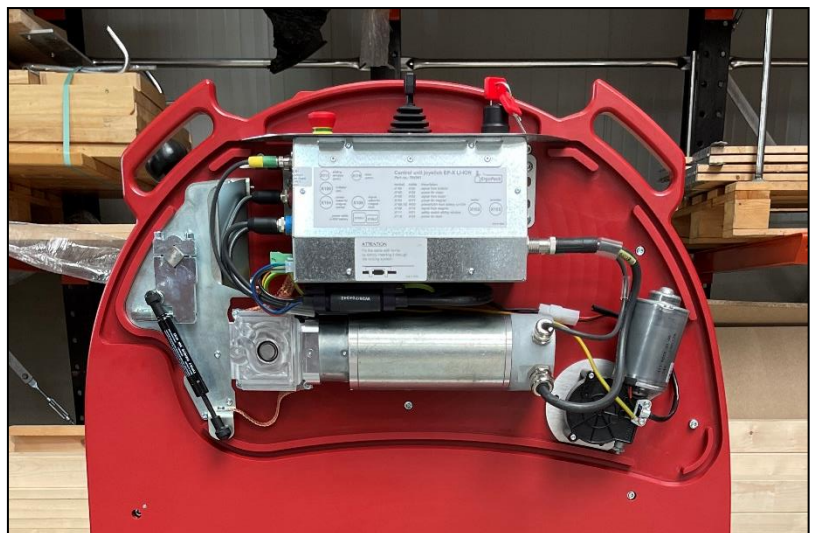

Fig. 100

Step 2

Unscrew the two plugs guided to the motor from the right side of the control box „joystick“ unit.



Attention!

The plugs are secured with a screw socket which has to be unlocked by turning it counter clockwise. Remove the plugs only afterwards.

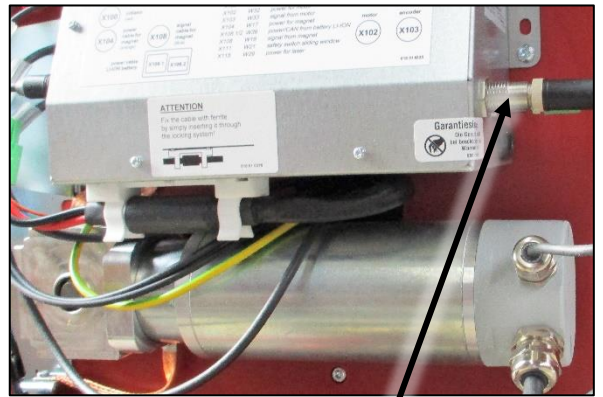

Fig. 101



Fig. 102

Step 3

First remove the 3 screws (103a) on the motor support plate , then remove the screw with the earth strap (103b) and ...

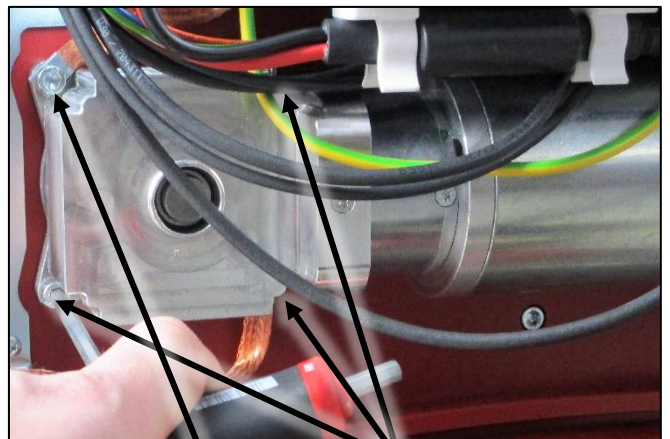

Fig. 103

103b

103a

... remove now the motor carefully.
Take care not to lose the feather key (104a).

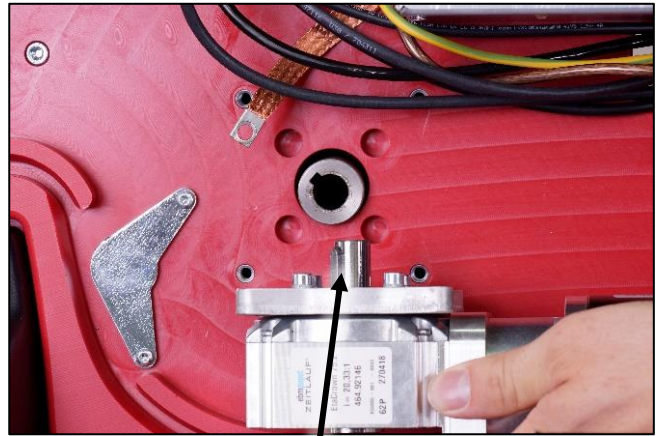

Fig. 104

104a

Step 4

The installation of the motor is done in the reversed order of the disassembling.



Attention!

The plug-in connection is positioned relative to one another through a plastic nose and groove. When having the correct position, connect the plug and secure it by the screw socket. This screw socket has to be closed by turning it clockwise. Only then, the function of the plug-in connection is ensured.

The feather key at the motor output has to be positioned exactly to the groove in the shaft.

10.12 Li-ion Battery Error Messages and cleaning

Error	Possible solution
All LEDs flash	Battery defective. ▶ Please contact ErgoPack service partner..
First LED flashes	Battery empty. ▶ Charge battery.
LEDs are off	▶ Switch on the battery. ▶ Check connection to strapping system/charger.
The battery does not charge	▶ Check the connection of the charger to the socket and to the charger.
The battery does not supply power	▶ Switch on the battery. ▶ Check connection to strapping system..
Mechanical defect	▶ Have checked by ErgoPack service partner.
Battery does Not work.	▶ Contact your ErgoPack service partner.

Cleaning:

If necessary, clean the battery with a dry cloth.

Keep the battery and contacts clean and dry. Clean dirty contacts with a dry cloth.



Note!

Send the defective Li-ion battery to the ErgoPack service partner. When shipping lithium-ion batteries, observe the interpretation and enforcement of the relevant regulations of the federal state authorities, see chapter 2.7.

10.13 Li-ion Charging Station/Charger Error messages and cleaning

Error	Possible solution
Red LED flashes	Battery fault. <ul style="list-style-type: none">▶ Disconnect the battery from the charger.▶ Please contact ErgoPack service partner.
Red LED lights up	Charger malfunction. <ul style="list-style-type: none">▶ Check the connection of the charger to the socket and to the battery.▶ Check the function of the fan on the charger.▶ Please contact ErgoPack service partner.
LEDs are off	<ul style="list-style-type: none">▶ Check the connection of the charger to the socket.▶ Check the mains switch on the charger.▶ Check the mains socket.▶ Please contact ErgoPack service partner.



Attention!

Do not make any modifications to the charger/charging station. Repairs may only be carried out by authorised specialist personnel.

Cleaning:

Disconnect the charger from the mains and then clean it with a dry or at most damp cloth.

Keep the charger clean and dry.

Send the defective Li-ion charger to your ErgoPack service partner.

11. Software Updates



Attention!

Updates on the control units „Joystick“ and „Display“ only through trained and properly instructed staff. The necessary access code will be provided by your ErgoPack service partner.

Step 1

Remove the cover „joystick“ as described in section 10.9 step 1 and take off the cover „display“ in accordance with the instructions in point 10.10 step 1 to 3.

Step 2

Remove the rubber plugs from the USB-ports (105a/106a).



Fig. 105

105a



Fig. 106

106a

Step 3

Press the „F3” button (1) on the display and click „next” (2) until page 6 (3) of the menu appears. Unlock the lock (4) with the corresponding access code.

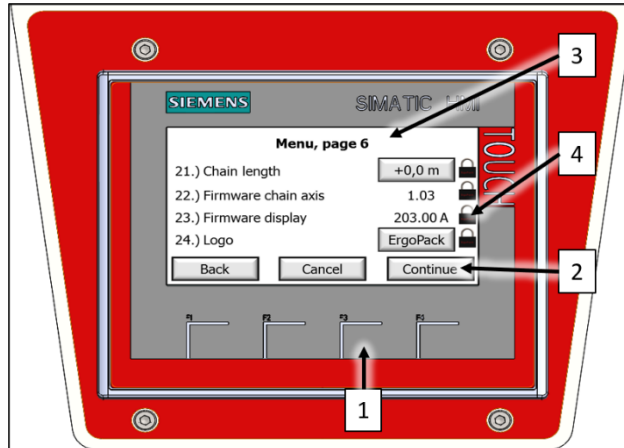

Fig. 107

Step 4

Firmware chain axis:

After unlocking, insert the USB stick with the current firmware into the USB port of the control unit „joystick” and start the update by confirming with „OK”.

As soon as the update was finished, the new version will be shown on the display!



Fig. 108

Step 5

Firmware display:

After unlocking, insert the USB stick with the current firmware into the USB port of the control unit „display” and start the update by confirming with „OK”. Proceed further as described on page 82.

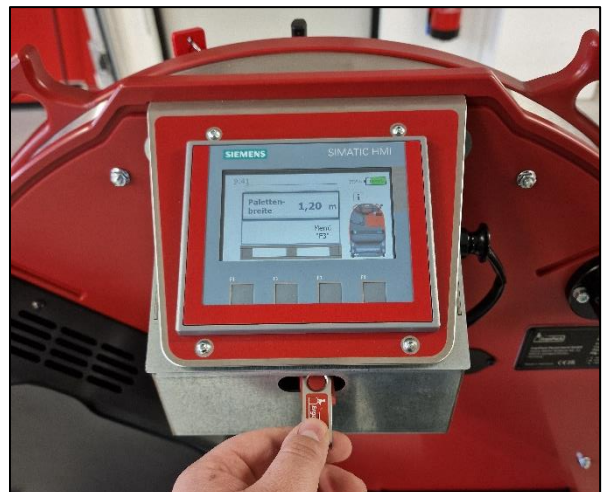

Fig. 109

Step 6

Procedure of the update "display":

After confirmation, the start center appears.

Select now „settings“.

Click on the file „Service & Commissioning“.

Select „Restore“

Search your USB-stick by clicking on „Search“. After your USB-stick was found, scroll down and click on „>“ to go to the next step.

Start searching the backup file by clicking on „Search“. After the backup file was found, change to the next step by clicking „>“ at the bottom right.

By confirming with „Accept“, the upload process starts automatically and the installation begins. As soon as the message „EMERGENCY STOP pressed“ appears, remove the USB-stick. After unlocking the „EMERGENCY STOP“, press „RESET“. Now you are in the main menu.

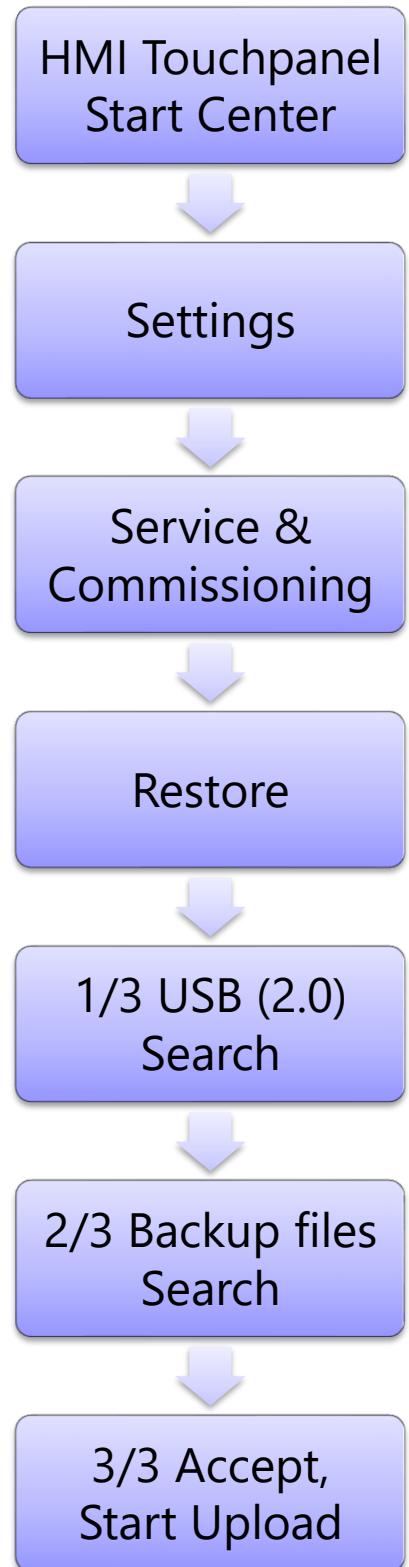

Fig. 115

12. Personal protective equipment



Inform yourself!

Before usage of the strapping system, the operating instructions have to be read carefully and understood. Service and maintenance on the strapping system have only to be done by trained staff.



Wear a safety helmet!

When strapping pallets higher than 1,20 m, a safety helmet has to be worn.

The duty wearing a helmet can be avoided, if the user was taught about the risk of injury by the plastic chain falling and that particular caution is required.

This instructions have to be recorded in writing.



Protect yourself!

Wear eye and hand protection (cut proof gloves) and also safety shoes.

13. General safety warnings for power tools



Warning !

Read all safety warnings and instructions. Failure to follow the warnings and instructions may result in electric shock, fire and/or serious injury.

Save all warnings and instructions for future reference.

The term „power tool“ in the warnings refers to your mains-operated (corded) power tool or battery-operated (cordless) power tool.

Work area safety

- a) **Keep the work area clean and well lit.** Cluttered or dark areas invite accidents.
- b) **Do not operate power tools in explosive atmospheres, such as in the presence of flammable liquids, gases or dust.** Power tools create sparks which may ignite the dust or fumes.
- c) **Keep children and bystanders away while operating a power tool.** Distractions can cause you to lose control.

Electrical safety

- a) **Power tool plugs must match the outlet. Never modify the plug in any way. Do not use any adapter plugs with earthed (grounded) power tools.** Unmodified plugs and matching outlets will reduce the risk of electric shock.
- b) **Avoid body contact with earthed or grounded surfaces such as pipes, radiators, ranges and refrigerators.** There is an increased risk of electric shock if your body is earthed or grounded.

- c) **Do not expose power tools to rain or wet conditions.** Water entering a power tool will increase the risk of electric shock.
- d) **Do not abuse the cord. Never use the cord for carrying, pulling or unplugging the power tool. Keep the cord away from heat, oil, sharp edges or moving parts.** Damaged or entangled cords increase the risk of electric shock.
- e) **When operating a power tool outdoors, use an extension cord suitable for outdoor use.** Use of a cord suitable for outdoor use reduces the risk of electric shock.
- f) **If operating a power tool in a damp location is unavoidable, use a residual current device (RCD) protected supply.** Use of an RCD reduces the risk of electric shock.

Personal safety

- a) **Stay alert, watch what you are doing and use common sense when operating a power tool. Do not use a power tool while you are tired or under the influence of drugs, alcohol or medication.** A moment of inattention while operating power tools may result in serious personal injury.
- b) **Use personal protective equipment. Always wear eye protection.** Protective equipment such as dust masks, non-skid safety shoes, hard hat or hearing protection used for appropriate conditions will reduce the risk of personal injuries.
- c) **Prevent unintentional starting. Ensure the switch is in the off-position before connecting to the power source and/or battery pack, picking up or carrying the tool.** Carrying power tools with your finger on the switch or energising power tools that have the switch on, invites accidents.
- d) **Remove any adjusting key or wrench before turning the power tool on.** A wrench or a key left attached to a rotating part of the power tool may result in personal injury.

- e) **Do not overreach. Keep proper footing and balance at all times.** This enables better control of the power tool in unexpected situations.
- f) **Dress properly. Do not wear loose clothing or jewellery. Keep your hair, clothing and gloves away from moving parts.** Loose clothes, jewellery or long hair can be caught in moving parts.
- g) **If devices are provided for the connection of dust extraction and collection facilities, ensure these are connected and properly used.** Use of dust collection can reduce dust-related hazards.

Power tool use and care

- a) **Do not force the power tool. Use the correct power tool for your application.** The correct power tool will do the job better and safer at the rate for which it was designed.
- b) **Do not use any power tool with a defective switch.** Any power tool that can not be controlled with the switch is dangerous and must be repaired.
- c) **Disconnect the plug from the power source and/or the battery pack from the power tool before making any adjustments, changing accessories, or storing power tools.** Such preventive safety measures reduce the risk of starting the power tool accidentally.
- d) **Store power tools out of the reach of children and do not allow persons unfamiliar with the power tool or these instructions to operate the power tool.** Power tools are dangerous in the hands of untrained operators.
- e) **Maintain power tools. Check for misalignment or binding of moving parts, breakage of parts and any other condition that may affect the power tool's operation. If damaged, have the power tool repaired before use.** Many accidents are caused by poorly maintained power tools.
- f) **Keep cutting tools sharp and clean.** Properly maintained cutting tools with sharp cutting edges are less likely to bind and are easier to control.

- g) Use the power tool, accessories and tool bits etc. in accordance with these instructions, taking into account the working conditions and the work to be performed.** Use of the power tool for operations different from those intended could result in a hazardous situation.

Battery tool use and care

- a) Recharge the battery packs only with the charger specified by the manufacturer.** A charger that is suitable for one type of battery pack may create a risk of fire when used with another battery pack.
- b) Use power tools only with specifically designated battery packs.** Use of any other battery packs may create risk of injury and fire.
- c) When the battery pack is not in use, keep it away from metal objects, like paper clips, coins, keys, nails, screws or other small metal objects, that can make a connection from one terminal to another.** Shorting the battery terminals together may cause burns or fire.
- d) Under abusive conditions, liquid may be ejected from the battery; avoid contact. If contact accidentally occurs, flush with water. If liquid contacts eyes, additionally seek medical help.** Liquid ejected from the battery may cause irritation or burns.

Service

- a) Have your power tool serviced by a qualified repair person using only identical replacement parts.** This will ensure that the safety of the power tool is maintained.

